

UCC-222  
CURATOR COPY

NASA SP-235

# APOLLO 12

## Preliminary Science Report

PML  
LIBRARY  
ACC. # 74

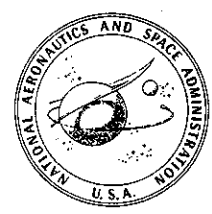

Sample Information Center  
NASA/JSC Building 31N  
PB.SAM.A12.1970.A 60120602

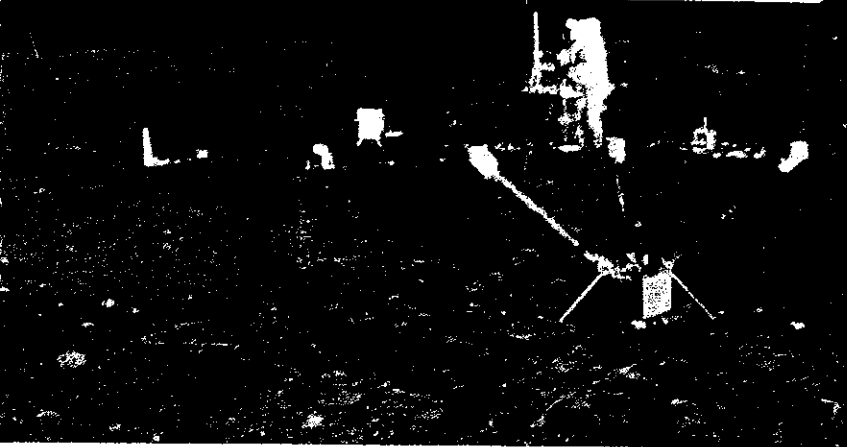
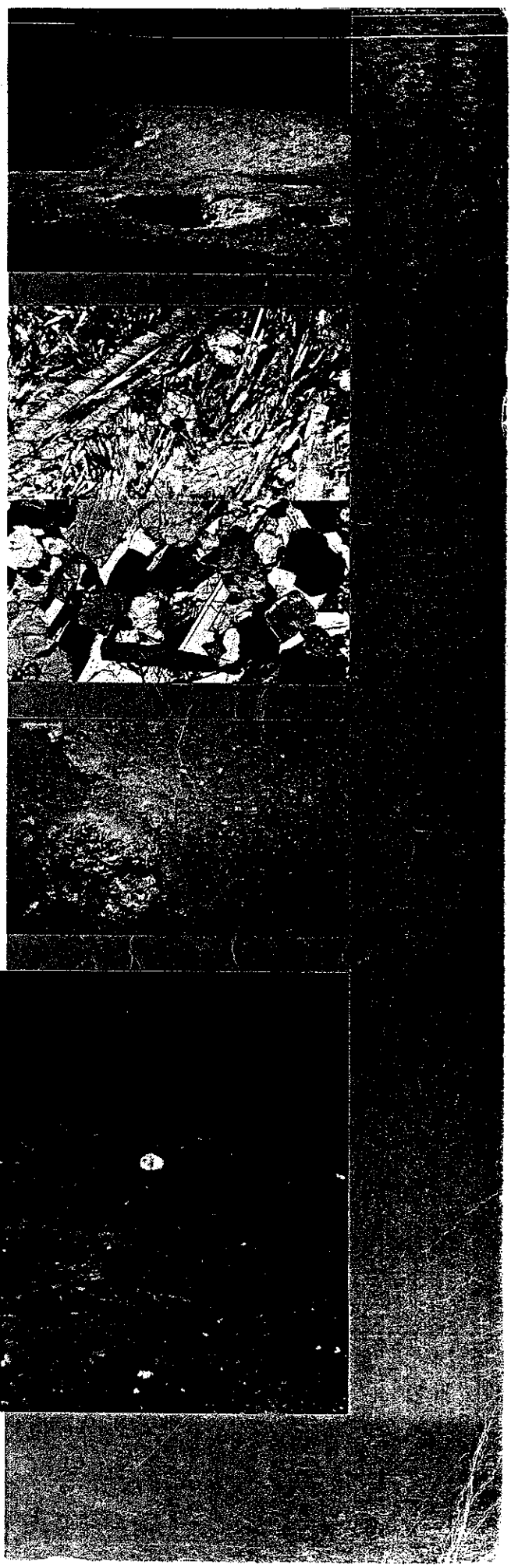

NATIONAL AERONAUTICS  
AND SPACE ADMINISTRATION

## 5. The Solar-Wind Spectrometer Experiment

Conway W. Snyder,<sup>a†</sup> Douglas R. Clay,<sup>a</sup> and Marcia Neugebauer<sup>a</sup>

The solar-wind spectrometer experiment was designed for the Apollo lunar surface experiments package (ALSEP) with the objective of detecting whatever solar plasma might strike the surface of the Moon. Thus, the spectrometer was required to be sensitive enough to detect the normal solar-wind flux at any angle in the lunar sky and to measure enough of the properties of the bulk solar wind to establish the nature of its interaction with the Moon. In 1966, at the time the experiment was proposed, nothing was known about this interaction. Subsequently, measurements of the solar wind and the magnetic field were made near the Moon by the lunar orbiter Explorer 35 (refs. 5-1 to 5-6). No evidence of a plasma shock ahead of the Moon was discovered, and the distortion of the solar-wind magnetic field by the Moon was observed to be very small. Both of these results imply that the solar wind probably strikes the surface directly, but they do not rule out the possibility of some more complex type of interaction very near the lunar surface and especially near the terminator plane. The Apollo 11 solar-wind composition experiment (ref. 5-7) detected rare gas atoms deposited in an aluminum foil on the lunar surface and demonstrated that the magnitude and direction of their incident velocity was very roughly as would be expected for the undisturbed solar wind.

The scientific objectives of the solar-wind spectrometer experiment are as follows:

(1) *The existence of the solar-wind plasma on the Moon* — to compare solar-wind properties measured at the lunar surface with those measured in space near the Moon to determine

whether the Moon has any effect on the solar plasma other than simply absorbing it

(2) *The properties of the lunar surface and interior* — to determine whether there are any subtle effects of the Moon on the solar-wind properties and to relate these effects to properties of the Moon such as its magnetic field, its electrical conductivity, the possibility of the Moon retaining an atmosphere, or the possible effect of solar corpuscular radiation on the lunar surface layer by the mechanism of sputtering or electrical charging

(3) *General solar-wind properties* — to study the motion of waves or discontinuities in the solar wind by measuring the time intervals between the observations of changes in plasma properties at the Moon and at the Earth

(4) *The magnetospheric tail of the Earth* — to make inferences as to the length, breadth, and structure of the magnetospheric tail of the Earth from continuous measurements made for 4 or 5 days around the time of full Moon

### Instrument Description

The basic sensor in the solar-wind spectrometer is a Faraday cup that measures the charged-particle flux entering the cup. By collecting these ions and using a sensitive current amplifier, the resultant current flow is determined. Energy spectra of positively and negatively charged particles are obtained by applying fixed sequences of square-wave ac retarding potentials to a modular grid and measuring the resulting changes in current. Similar detectors have been flown on a variety of space probes. Such detectors are described in reference 5-8.

To be sensitive to solar-wind plasma from any direction (above the horizon of the Moon) and to ascertain the solar-wind angular distribution,

<sup>a</sup> Jet Propulsion Laboratory, California Institute of Technology.

<sup>†</sup> Principal investigator.

the solar-wind spectrometer has an array of seven cups. Since the cups are identical, an isotropic particle flux would produce equal currents in each cup. If the flux is not isotropic but appears in more than one cup, analysis of the relative amounts of current in the collectors can provide information on the direction of plasma flow and its anisotropy. The central cup faces vertically, and the remaining six cups symmetrically surround the central cup. Each of the six cups faces  $60^\circ$  off vertical. The combined acceptance cones of all cups cover most of the upward hemisphere. Each cup has a circular opening, five circular grids, and a circular collector (fig. 5-1). The functions of the grid structures are to apply an ac modulating field to incoming particles and to screen the modulating field from the inputs to the sensitive preamplifiers. The entrance apertures of the cups were protected from damage or dust by covers that remained in place until after the departure of the lunar module. The angular dependence of the Faraday-cup sensor has been measured by laboratory plasma calibrations. The result, averaged over all seven cups, is shown in figure 5-2 and agrees quite well with the measured optical transparency.

The electronics for the solar-wind spectrometer is in a temperature-controlled container that hangs below the sensor assembly. The electronics includes power supplies, a digital programmer that controls the voltages in the sensors as required, current-measuring circuitry, and data-conditioning circuits.

The solar-wind spectrometer operates in an invariable sequence in which a complete set of

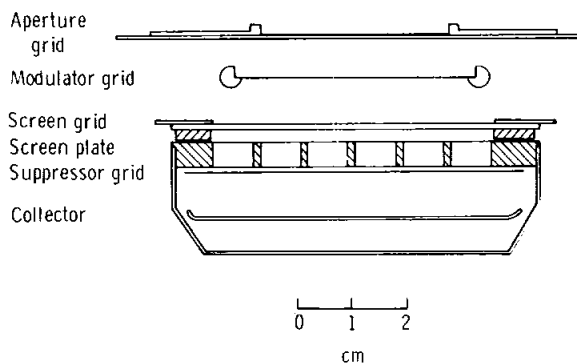

FIGURE 5-1. — Faraday-cup sensor.

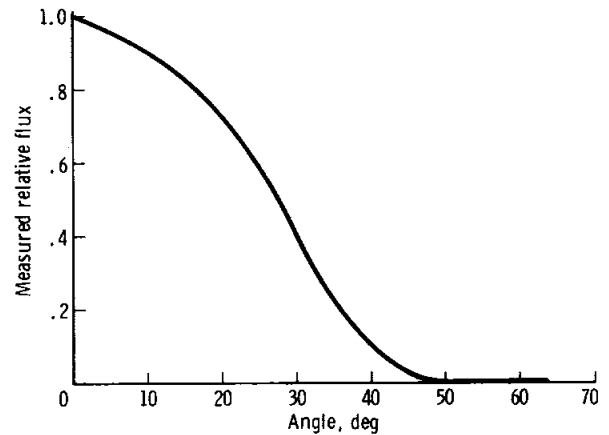

FIGURE 5-2. — Angular response of the Faraday cup.

plasma measurements is made every 28.1 sec. The sequence consists of 14 energy steps spaced a factor of  $\sqrt{2}$  apart for positive ions and seven energy steps spaced a factor of 2 apart for electrons. A large number of internal calibrations are provided, and every critical voltage is read out at intervals of 7.5 min or less.

On the Moon, the solar-wind spectrometer is hung from a pair of knife edges so that it is free to swing about an east-west horizontal axis and, hence, is self-leveling in one dimension. Leveling about the north-south axis is indicated by a Sun sensor that peaks at the time that the Sun is  $30^\circ$  east of the axis of the central cup.

### Instrument Deployment

The solar-wind spectrometer was deployed without difficulty by Astronaut Charles Conrad, Jr. Figure 5-3 shows the spectrometer on the lunar surface. From the pattern of the shadow on the radiator (left side of the instrument), it has been determined that the east-west axis of the instrument is actually aligned approximately  $2.8^\circ$  north of east. The data from the Sun sensor indicate that the axis is off level by approximately  $2.5^\circ$ , with the west edge low. Both these values are well within specified limits. The level about the east-west axis cannot be determined from the photograph but should be insured by the self-leveling suspension.

Shortly after deployment, the spectrometer was turned on to provide background data with the sensor covers in place. Approximately 1 hr

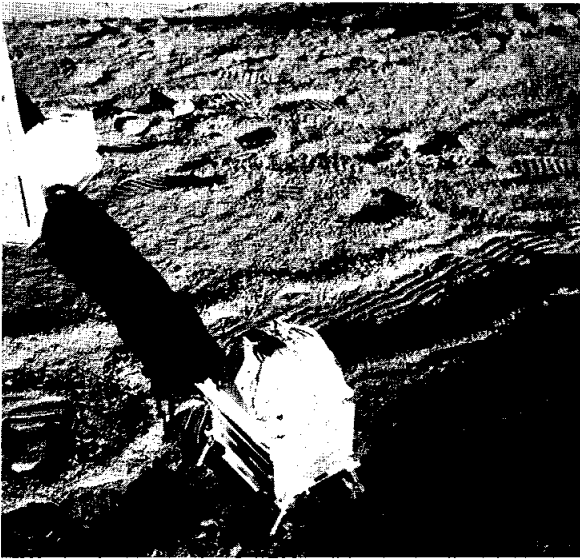

FIGURE 5-3. — Solar-wind spectrometer experiment deployed on the Moon.

after lunar module ascent, the covers were removed by command from Earth, and detection of solar plasma began.

### Instrument Performance

During the first month, the solar-wind spectrometer has operated as expected. All functions have performed properly. The thermal control has proved adequate with temperatures ranging between  $-16^{\circ}$  and  $+63^{\circ}$  C inside the electronics package and between  $-134^{\circ}$  and  $+63^{\circ}$  C inside the sensor assembly. Comfortable margins for possible future degradation exist, because thermal vacuum tests have demonstrated no adverse effects of electronics package temperatures from  $+108^{\circ}$  and  $+100^{\circ}$  C or of sensor temperatures from  $-147^{\circ}$  to  $+111^{\circ}$  C.

### Types of Spectra Observed

The data discussed in this report have been obtained from the high-speed printer in the ALSEP control room at the NASA Manned Spacecraft Center. The data consist of intermittent samples of data from 1 to 8 min in duration. The positive-ion spectra observed have been of the following general types:

(1) The peak current is in an energy window corresponding to a proton velocity of 400 to

550 km/sec. The bulk of the remaining currents is in the two adjacent energy windows, and a small (4 to 10 percent) current is in the second higher energy window. Figure 5-4 is a histogram of a typical spectrum of this type. This type of spectrum would be expected for the unperturbed (normal interplanetary) solar wind.

(2) The second type of spectrum has a peak current in a window corresponding to a proton velocity of 250 to 450 km/sec and has significant currents in several adjacent windows on either side of the peak. Such spectra typically have positive-ion densities of approximately 5 particles/cm<sup>3</sup>, and adjacent spectra (spaced 28.1 sec apart) often show large velocity changes. Double-peaked spectra occasionally appear, probably indicating rapid velocity fluctuations. Figure 5-5 is a histogram of a typical spectrum of the second spectrum type. Such spectra are typical of the transition region between the Earth bow shock and the geomagnetosphere. However, other sources of perturbation, such as solar conditions at the time the solar-wind particles left the Sun or lunar interaction with the solar wind, cannot be ruled out until further information is available.

(3) At times, detectable currents appear in only one energy step or in two adjacent steps so that certain plasma properties, such as velocity distribution, are not calculable for these positive-ion spectra.

(4) During most of the lunar night, there is no detectable flux of solar-wind particles within the 100- to 900-km/sec range of the solar-wind spectrometer.

A further type of spectrum for positive ions was observed early on November 27, 1969, but for only a few hours. This special type of spectrum had characteristics that were highly variable in time. Many such spectra were of the perturbed solar-wind type except for increased fluxes in all windows from 180 to 900 km/sec (and perhaps beyond, since the spectrometer was in low modulation gain, and higher velocities were not measured) and except for significant fluxes detected in other cups facing as far as  $60^{\circ}$  from the Sun angle. One of these spectra is shown in figure 5-6. These spectra are not typical and do not seem to fit easily into the general types listed previously.

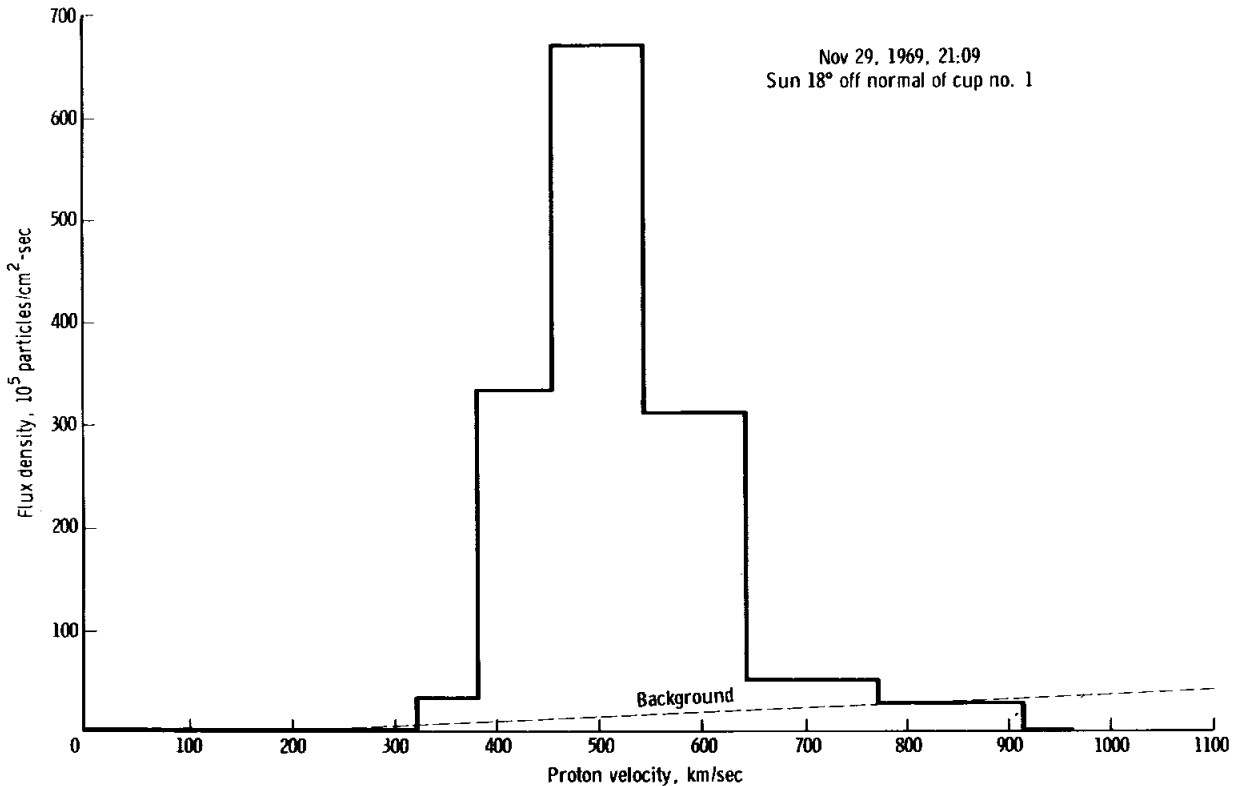

FIGURE 5-4. — Typical positive-ion spectrum obtained in the interplanetary solar wind. The background reading of each cup is slightly dependent upon modulation voltage, which is caused primarily by pickup in the electrometer inputs. Until all the data become available and are analyzed, this background is only estimated, giving an uncertainty in readings in the higher velocity windows. The magnitude of this source of uncertainty is indicated in each spectrum as a dashed line labeled "background."

The electron component of the solar wind has also been detected. However, since this type of plasma probe typically does not completely distinguish between plasma electrons and photoelectrons, interpretation of the data is difficult. Analysis of the complete data from magnetic tape will be required before conclusions can be drawn from the electron data. The times of appearance and disappearance of photoelectrons gave clear indications of sunset and sunrise.

### Observations

At the time of solar-wind spectrometer dust-cover removal (15:25:30 G.m.t. on November 20, 1969), the positive-ion spectra observed were of the second type (perturbed solar wind), and the lunar surface magnetometer indicated that the Moon was behind the plasma bow shock of the

Earth. This type of solar-wind data continued, with large fluctuations in bulk velocity and density, until approximately 03:00 G.m.t. on November 21, 1969, when a region of no plasma was observed. For the next 5 days, there were only occasional sampling periods of spectrometer printout that indicated plasma was present (always of the second type). The magnetometer indicated that the Moon was in the magnetospheric tail of the Earth (fig. 5-7).

Commencing at approximately 10:00 G.m.t. on November 26, 1969, the solar-wind spectrometer entered a region wherein the majority of spectra were of the second type (perturbed). From approximately 12:00 G.m.t. on November 28, 1969 (when the magnetometer indicated passage out through the bow shock into interplanetary space), until sunset on December 3, 1969,

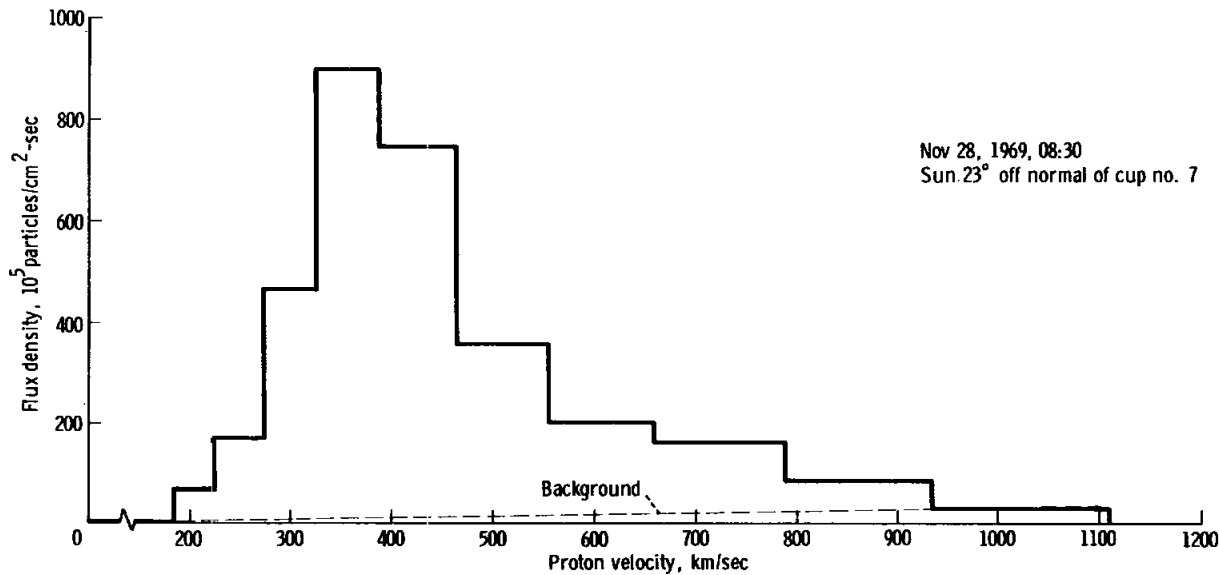

FIGURE 5-5. — Typical positive-ion spectrum obtained in the magnetospheric tail (perturbed solar wind) of the Earth.

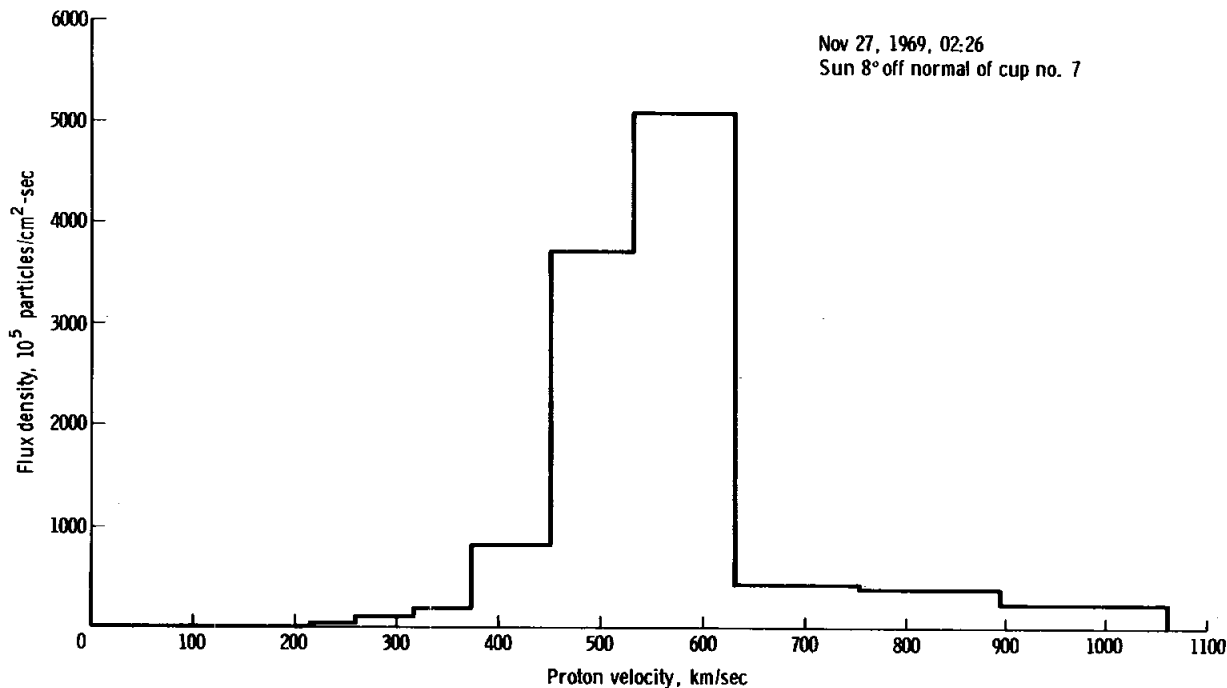

FIGURE 5-6. — One of many unusual spectra obtained on November 27, 1969.

the spectra were mainly of the first type (interplanetary solar wind); although fairly frequent, the flux density became low enough to make classification according to spectrum type difficult. Later during November 28, 1969, several

short periods of type (2) spectra were tentatively identified.

As indicated by the cessation of photoelectrons detected in the cup nearest the solar direction, the spectrometer was in darkness beginning at

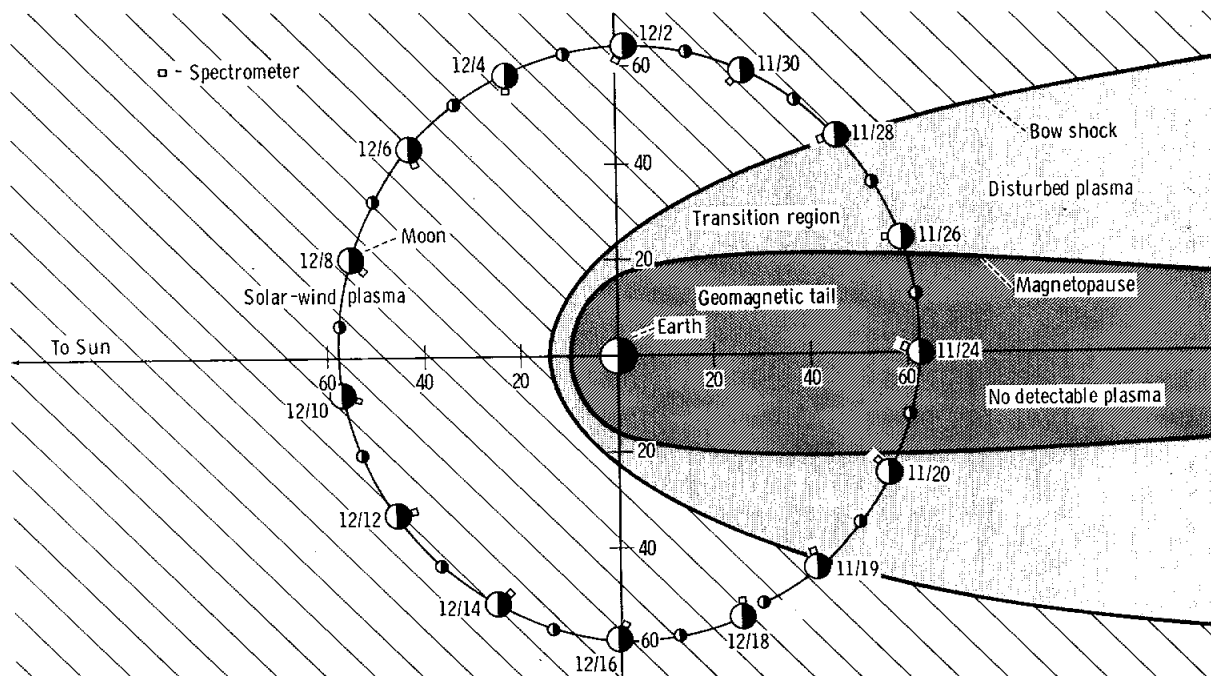

FIGURE 5-7. — Solar-wind plasma regions.

15:22:20 G.m.t. on December 3, 1969. For several hours preceding sunset, the density of the solar-wind plasma had appeared to decrease steadily, but this apparent behavior may be partially caused by reduced detector sensitivity at angles near the horizon. The plasma signal continued to decrease until between 19:00 and 20:00 G.m.t. on December 3, 1969, when the instrument threshold of sensitivity was reached. In the following 14 days of lunar darkness, no times of plasma detection have been observed in the limited data scanned.

The first photoelectrons of sunrise were detected at 11:38 G.m.t. on December 18, 1969, and within 20 min the first telemetry indication of warming of the sensor assembly was received. However, by sunrise, protons of the solar wind had been observed for nearly 12 hr. Several large fluctuations in proton flux occurred, varying from a high flux approximately 18 min before sunrise to no detectable plasma as late as 15 min after sunrise. These fluctuations may be caused by changes in the solar-wind flux or flow direction or by a lunar interaction effect. Comparison with interplanetary solar-wind data will

be required to resolve this uncertainty. Data samples for December 22 to 24, 1969, also show no detectable plasma, probably because the instrument was once more in the magnetospheric tail of the Earth.

Typically, the preponderance of flux entered only one cup — the one most nearly facing the Sun. However, during the time when the solar-wind spectrometer was most sensitive to angular variations, from 12:00 G.m.t. on November 28, 1969, to 8:00 G.m.t. on November 29, 1969, there were indications that the direction of bulk velocity varied as much as  $\pm 10^\circ$  from the mean angle  $2^\circ$  to  $4^\circ$  east of the optical direction of the Sun. This is the only time span for which angular information is now available.

### Summary and Results

This report is based upon examination of the printer output of the data for the first 35 days after deployment of the solar-wind spectrometer. These data are only a small percentage of the data that will ultimately be available for this period.

The solar plasma at the lunar surface is superficially indistinguishable from that at a distance from the Moon, both when the Moon is ahead of and when the Moon is behind the plasma bow shock of the Earth. No detectable plasma appears to exist in the magnetospheric tail of the Earth or in the shadow of the Moon.

Times of passage through the bow shock or through the magnetospheric-tail boundary, as indicated by the solar-wind spectrometer and by the lunar surface magnetometer, are in agreement when comparison of data has been possible. These times are given more accurately in the lunar surface magnetometer experiment section of this document.

Generally, observations have been in accordance with expectations, but the highly variable spectra observed on November 27, 1969, and at sunrise may prove to involve unexpected phenomena. Complete data and detailed comparison with other solar-wind measurements will be required before firm or quantitative conclusions can be drawn.

### References

- 5-1. COLBURN, D. S.; CURRIE, R. G.; MIHALOV, J. D.; and SONETT, C. P.: Diamagnetic Solar-Wind Cavity Discovered Behind Moon. *Science*, vol. 158, no. 3804, Nov. 24, 1967, pp. 1040-1042.
- 5-2. SONETT, C. P.; COLBURN, D. S.; and CURRIE, R. G.: The Intrinsic Magnetic Field of the Moon. *J. Geophys. Res.*, vol. 72, no. 21, Nov. 1, 1967, pp. 5503-5507.
- 5-3. NESS, N. F.; BEHANNON, K. W.; TAYLOR, H. E.; and WHANG, Y. C.: Perturbations of the Interplanetary Magnetic Field by the Lunar Wake. *J. Geophys. Res.*, vol. 73, no. 11, June 1, 1968, pp. 3421-3440.
- 5-4. NESS, N. F.; BEHANNON, K. W.; SCEARCE, C. S.; and CANTARNO, S. C.: Early Results from the Magnetic Field Experiment on Lunar Explorer 35. *J. Geophys. Res.*, vol. 72, no. 23, Dec. 1, 1967, pp. 5769-5778.
- 5-5. LYON, E. F.; BRIDGE, H. S.; and BINSACK, J. H.: Explorer 35 Plasma Measurements in the Vicinity of the Moon. *J. Geophys. Res.*, vol. 72, no. 23, Dec. 1, 1967, pp. 6113-6117.
- 5-6. SISCOE, G. L.; LYON, E. F.; BINSACK, J. H.; and BRIDGE, H. S.: Experimental Evidence for a Detached Lunar Compression Wave. *J. Geophys. Res.*, vol. 74, no. 1, Jan. 1, 1969, pp. 59-69.
- 5-7. BUEHLER, F.; EBERHARDT, P.; GEISS, J.; MEISTER, J.; and SIGNER, P.: Apollo 11 Solar Wind Composition Experiment: First results. *Science*, vol. 166, no. 3912, Dec. 19, 1969, pp. 1502-1503.
- 5-8. HUNDHAUSEN, A. J.: Direct Observations of Solar Wind Particles. *Space Sci. Rev.*, vol. 8, no. 5/6, 1968, pp. 690-749.

### ACKNOWLEDGMENTS

In the 51 months between the proposal of the solar-wind spectrometer for ALSEP and its successful deployment on the Moon, a rather large number of people contributed significantly to the design, development, and testing of the instrument. The authors regret that it is not practicable to acknowledge all of them. Among the engineers at the Jet Propulsion Laboratory whose deep and prolonged involvement in the project was clearly indispensable were David D. Norris, Gary L. Reisdorf, James W. Rotta, Jr., Gary J. Walker, and Robert H. White. Albert J. Fender, the quality assurance representative, should be added to this list.

The initial design and fabrication of the electronics package was done by Electro-Optical Systems, Inc. (EOS) of Pasadena, Calif. Among EOS employees who made major contributions, the authors particularly wish to express appreciation to Bill F. Lane, Thomas D. MacArthur, and Richard D. McKeethan. The instrument integration team at Bendix Aerospace Division, Ann Arbor, Mich., under Charles J. Weathered was always responsive to suggestions, and the authors are especially indebted to Albert D. Robinson, who was the instrument engineer. Recognition is also due to the NASA Manned Spacecraft Center engineers, Richard A. Moke, Carl O. McClenny, Ausley B. Carraway, and William P. LeCroix, who had management cognizance of the instrument at various times.

This report presents the results of one phase of research carried out at the Jet Propulsion Laboratory, California Institute of Technology, under NASA Contract NAS 7-100, sponsored by the National Aeronautics and Space Administration.