

FC036
1/15/69



NATIONAL AERONAUTICS AND SPACE ADMINISTRATION

APOLLO LUNAR SURFACE EXPERIMENTS PACKAGE SYSTEMS HANDBOOK

ALSEP 1

JANUARY 15, 1969

PREPARED BY

FLIGHT CONTROL DIVISION

MANNED SPACECRAFT CENTER
HOUSTON, TEXAS

1 INTRODUCTORY
INFORMATION

2 GENERAL
DESCRIPTION

3 STRUCTURAL
THERM CONTROL
SUBSYSTEM

4 ELECTRICAL
POWER
SUBSYSTEM

5 COMMAND
SUBSYSTEM

6 TELEMETRY
SUBSYSTEM

7 DUST DETECTOR
SUBSYSTEM

8 PASSIVE
SEISMIC
EXPERIMENT

9 LSM
EXPERIMENT

10 SWS
EXPERIMENT

11 SIDE/CCGE
EXPERIMENT

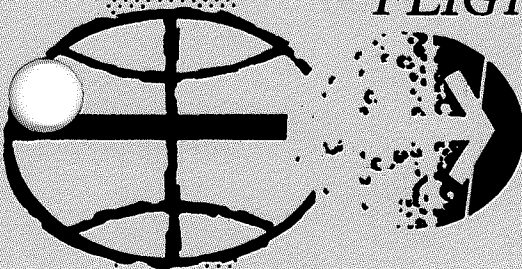

UNITED STATES GOVERNMENT

Memorandum

TO : Recipients of the ALSEP 1 Systems Handbook

DATE: SEP 17 1969

FROM : FC/Chief, Flight Control Division
NASA - Manned Spacecraft Center, Houston, Texas

SUBJECT: Transmittal of Change 1 to the Apollo Lunar Surface Experiments
Package Systems Handbook, ALSEP 1

Attached are the Change Instruction Sheet and revised drawing which together comprise Change 1 to the ALSEP 1 Systems Handbook.

Since the ALSEP 1 Systems Handbook is a one-time document and since this change revises only one drawing, a Publication Control and Item Effectivity Sheet has not been included. The pages which have been changed are included on the Change Instruction Sheet and are effective as of the date of Change 1.

Please update your handbook immediately in accordance with the Change Instruction Sheet which follows this page.

Eugene F. Kranz
Chief, Flight Control Division



5010-108

Buy U.S. Savings Bonds Regularly on the Payroll Savings Plan

*

APOLLO LUNAR SURFACE EXPERIMENTS PACKAGE SYSTEMS HANDBOOK

ALSEP 1

PREFACE

This document has been prepared by the Flight Control Division, Manned Spacecraft Center, Houston, Texas. Information contained within this document represents the Apollo Lunar Surface Experiments Package (ALSEP) Number One (1) as of January 15, 1969, and completely replaces the ALSEP Systems Handbook of October 16, 1967.

This document is intended for specialized use by Experiment Flight Controllers in real-time and near-real-time operations.

Comments regarding this handbook should be directed to the Space Sciences Group of the Experiments Systems Branch. Revisions will be issued as required prior to the flight date.

This document is not to be reproduced without the written approval of the Chief, Flight Control Division, Manned Spacecraft Center, Houston, Texas.

Approved by:

James E. Saultz
Chief, Experiment Systems Branch

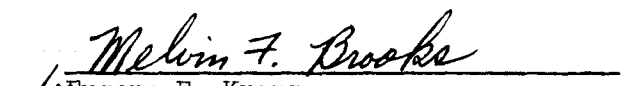
for Eugene F. Kranz
Chief, Flight Control Division

*

APOLLO LUNAR SURFACE EXPERIMENTS PACKAGE
SYSTEMS HANDBOOK

ALSEP 1

CHANGE 1

CHANGE INSTRUCTION SHEET

Update this document in accordance with the following instructions:

Remove and replace the following page:

8-4 (Drawing 8.1)

Add the following new page:

iaa

iaa

*

CONTENTS

Section	Page
1 <u>INTRODUCTORY INFORMATION</u>	1-1
1.1 ALSEP'S 1 THROUGH 4 ABBREVIATIONS AND ACRONYMS	1-1
1.2 <u>DRAWING SYMBOL STANDARDS</u>	1-7
1.2.1 <u>General Drawing Information</u>	1-7
1.2.2 <u>Line Legend</u>	1-8
1.2.3 <u>Telemetry Symbols</u>	1-10
1.2.4 <u>Electrical Symbols</u>	1-11
1.2.5 <u>Special ALSEP Symbols</u>	1-16
2 <u>GENERAL DESCRIPTION</u>	2-1
2.1 ALSEP DESCRIPTION	2-1
3 <u>STRUCTURAL/THERMAL CONTROL SUBSYSTEM</u>	3-1
4 <u>ELECTRICAL POWER SUBSYSTEM</u>	4-1
4.1 <u>SYSTEM DESCRIPTION</u>	4-1
4.1.1 <u>Radioisotope Thermoelectric Generator (RTG)</u>	4-1
4.1.2 <u>Power Conditioning Unit (PCU)</u>	4-1
4.1.3 <u>Power Distribution Unit (PDU)</u>	4-1
5 <u>COMMAND SUBSYSTEM</u>	5-1
5.1 <u>SYSTEM DESCRIPTION</u>	5-1
5.1.1 <u>S-band Antenna</u>	5-1
5.1.2 <u>Diplexer Filter</u>	5-1
5.1.3 <u>Command Receiver</u>	5-1
5.1.4 <u>Command Decoder</u>	5-2
5.2 <u>COMMAND FUNCTIONS</u>	5-5
6 <u>TELEMETRY SUBSYSTEM</u>	6-1
6.1 <u>SYSTEM DESCRIPTION</u>	6-1
6.1.1 <u>Sensors (Transducers)</u>	6-1
6.1.2 <u>Analog Multiplexer</u>	6-1
6.1.3 <u>A/D Converters</u>	6-1
6.1.4 <u>Digital Data Processor</u>	6-1

*

Section	Page
6.1.5 <u>Transmitter</u>	6-2
6.1.6 <u>Diplexer Switch</u>	6-2
7 <u>DUST DETECTOR SUBSYSTEM</u>	7-1
7.1 SYSTEM DESCRIPTION	7-1
8 <u>PASSIVE SEISMIC EXPERIMENT (S031)</u>	8-1
8.1 SYSTEM DESCRIPTION	8-1
9 <u>LUNAR SURFACE MAGNETOMETER EXPERIMENT (S034)</u>	9-1
9.1 SYSTEM DESCRIPTION	9-1
9.2 FLIP CALIBRATION SEQUENCE	9-4
9.3 SITE SURVEY SEQUENCE	9-6
9.3.1 <u>X-axis Site Survey Sequence</u>	9-6
9.3.2 <u>Y-axis Site Survey Sequence</u>	9-6
9.3.3 <u>Z-axis Site Survey Sequence</u>	9-6
10 <u>SOLAR WIND SPECTROMETER EXPERIMENT (S035)</u>	10-1
10.1 SYSTEM DESCRIPTION	10-1
11 <u>SUPRATHERMAL ION DETECTOR EXPERIMENT/COLD CATHODE GAGE EXPERIMENT (S036)</u>	11-1
11.1 SYSTEM DESCRIPTION	11-1

*

TABLES

Table		Page
4-I	PCU OVER AND UNDER VOLTAGE	4-8
4-II	POWER CALCULATIONS	4-9
4-III	PDU RELAY INITIAL CONDITIONS	4-9
4-IV	CIRCUIT BREAKER AND FUSE TABULATION	4-10
4-V	VOLTAGE DISTRIBUTION AND BUS LOAD ANALYSIS	4-11
4-VI	COMMANDS CAUSING Δ POWER DEMAND	4-12
4-VII	CENTRAL STATION STEADY STATE POWER DEMANDS ON EACH VOLTAGE BUS FROM THE PCU	4-14
4-VIII	RELAY DRIVER FUNCTIONS AND INPUT VOLTAGE REQUIREMENTS	4-15
5-I	ANTENNA OPERATING PARAMETERS	5-1
5-II	RECEIVER CHARACTERISTICS	5-1
5-III	RECEIVER POWER REQUIREMENTS	5-2
5-IV	CENTRAL STATION TIMER CHARACTERISTICS	5-4
5-V	COMMAND DECODER POWER REQUIREMENTS	5-4
6-I	ANALOG MULTIPLEXER A/D CONVERTER CHARACTERISTICS	6-3
6-II	DIGITAL DATA PROCESSOR CHARACTERISTICS	6-3
6-III	TIMING FROM DIGITAL PROCESSOR	6-6
6-IV	TIMING AND CONTROL PULSE CHARACTERISTICS	6-6
6-V	TELEMETRY SUBSYSTEM POWER REQUIREMENTS AND OVERLOAD PROTECTION	6-7
6-VI	TRANSMITTER CHARACTERISTICS	6-7
6-VII	REDUNDANT ANALOG CHANNELS	6-8
6-VIII	CHANNEL MEASUREMENT ASSIGNMENTS FOR ANALOG MULTIPLEXER (ALSEP WORD 33)	6-9
6-IX	EXPERIMENT OFF DOWNLINK STATUS	6-10
6-X	ALSEP 1 ANALOG CHANNEL USAGE	6-11
6-XI	PASSIVE SEISMIC MEASUREMENTS LIST, ALSEP 1	6-13
6-XII	LUNAR SURFACE MAGNETOMETER MEASUREMENTS LIST, ALSEP 1	6-14
6-XIII	LUNAR SURFACE MAGNETOMETER 16 POINT ENGINEERING SUBCOMMUTATION FORMAT AND ENGINEERING STATUS BIT STRUCTURE LOCATED IN ALSEP 1 MAIN FRAME, WORD 5	6-15

*

Table		Page
6-XIV	SOLAR WIND SPECTROMETER (SWS) MEASUREMENTS LIST, ALSEP 1	6-16
6-XV	LIMITS OF SWS ENGINEERING DATA	6-21
6-XVI	SUPRATHERMAL ION DETECTOR AND COLD CATHODE GAGE EXPERIMENT MEASUREMENTS LIST, ALSEP 1	6-22
8-I	PRESET CONDITIONS	8-1
8-II	LEVELING RATES	8-2
9-I	PRESET CONDITIONS	9-2
10-I	SWS TELEMETRY FORMAT	10-3
11-I	SIDE/CCGE PRESET CONDITIONS	11-2
11-II	GROUND PLANE STEPPER SEQUENCE	11-2
11-III	SIDE WORD TWO TELEMETRY	11-3

*

FIGURES

Figure	Page
2-1 ALSEP/LM interface.	2-2
4-1 RTG warmup characteristics.	4-4
4-2 RTG hot and cold frame temps vs RTG current.	4-5
4-3 ALSEP 1 power dissipation distribution.	4-6
4-4 PCU load vs RTG power output vs central station dissipation.	4-7
4-5 Relay driver voltages.	4-15
4-6 Lunar day power profile.	4-16
4-7 Lunar day to night power profile.	4-17
4-8 Internal regulator dissipation.	4-18
6-1 ALSEP 1 main frame format.	6-4
6-2 Control and command verification word format.	6-5
7-1 Dust detector.	7-2
8-1 PSE power profile.	8-3
9-1 LSM power profile.	9-3
10-1 SWS power profile.	10-2
11-1 SIDE/CCGE power profile.	11-4
11-2 Programed sensor voltage variations (normal cycle).	11-5
11-3 Programed sensor voltage variations (reset at 10).	11-6
11-4 Programed sensor voltage variations (reset at 39 and 79).	11-7
11-5 Programed sensor voltage variations (reset at 9).	11-8

*

DRAWINGS

Drawing	Page
3.1 Sunshield	3-1
3.2 Thermal plate	3-2
3.3 Primary structure	3-3
3.4 Thermal bag	3-4
3.5 Central station sensors, heater, and switches	3-5
4.1 RTG temperature sensor locations	4-3
4.2 Power distribution and functional block diagram	4-19
5.1 Command subsystem	5-16
6.1 Telemetry subsystem	6-29
6.2 Mechanical analogy of telemetry commutations	6-30
6.3 Central station and RTG instrumentation diagram	6-31
7.1 Dust detector schematic	7-3
8.1 PSE system schematic	8-4
9.1 LSM flip calibration sequence	9-5
9.2 LSM X, Y, Z site survey sequences	9-7
9.3 LSM system schematic	9-8
10.1 SWS system schematic	10-4
11.1 SIDE/CCGE system schematic	11-9

**1 INTRODUCTORY
INFORMATION**

INTRODUCTORY INFORMATION

1.1 ALSEP'S 1 THROUGH 4 ABBREVIATIONS AND ACRONYMS

NOTE

Due to reduction requirements, acronyms which would normally be in lower case, for example, "dc," will appear in upper case on drawings. The text will, however, conform to NASA standards.

ac	alternating current
ACCPT	accept
ACK	acknowledge
A/DC	analog-to-digital converter
Adc	amperes dc
ADD	address
AGC	automatic gain control
ALIGN	alignment
ALSEP	Apollo Lunar Surface Experiments Package
A/F	automatic/forced
AMPS	amperes
ANT	antenna
APP	approximate, approximately
ARM	armed
ASC	ascent
ASE	Active Seismic Experiment
AUTO	automatic
AZ	azimuth
B1	bottom location of structure temperature
BAS	base
BER	bit error rate
BPS	bits per second
C	centigrade
CAL	calibrate
CALC	calculated
CB	circuit breaker
CBL	cable
CCGE	Cold Cathode Gage Experiment (part of SIDE)
CCGE/A } CCGE/D }	analog and digital ID readout from CCGE
CCIG	Cold Cathode Ion Gage (instrument portion of CCGE)
CCW	counterclockwise
CH	channel
CH	change
CHAN	Channeltron; used in CPE as: CHAN/1 Channeltron P/S #1 CHAN/2 Channeltron P/S #2 CHAN/HI Channeltron Voltage Increase ON CHAN/LO Channeltron Voltage Increase OFF
CLD	cold
CMD	command
CNT	count
CNTS	counts
CNTR	counter

COMM	communications
CONV	converter
CPLEE or CPE	Charged-Particle Experiment (full name is Charged-Particle Lunar Environment Experiment)
CPS	cycles per second
CS	central station
CTL	control
CUR	current
CVR	cover
CVR/S	cover and seal (used on SIDE)
CVW	command verification word
CW	clockwise
db	decibels
dbm	decibels with respect to one milliwatt
dc	direct current
DEC	decoder
DECR	decrease
DEF	deflection
DEG	degrees
DESC	descent
DET	detector
DIG	digital
DIR	direction
DIR/V	direction and speed (used on PSE)
DISSIP	dissipation
DLAY	delay
D/P	data processor
DPLY	deploy
DRT	dome removal tool
DSS	Data Subsystem; components include: DSS/A Analog Data Processor DSS/D Digital Data Processor DSS/PROC Complete Data Processor (Redundant)
EGFU	Electronics/Gimbal-Flip Unit
ENBL	enable
EPS	Electrical Power System
EV	electron volts
EXP	experiment
EXT	external
F	fuse
F	Fahrenheit
FET	field effect transistor
FILT	filter
FLD	field
FREQ	frequency
FTT	fuel transfer tool
FWD	forward

GDT	gradient sensor delta temperatures (HFE)
GEO	geophone
GLA	Grenade Launch Assembly (a component of ASE)
GMBL	gimbal
GND	ground
GT	gradient sensor ambient temperatures (HFE)
HBR	high bit rate
HECPA	High-Energy Curved Plate Analyzer (a component of SIDE)
HFE	Heat Flow Experiment
HI	high
HTR	heater: On HFE there are two cases: HTR/HK High Conductivity Heater HTR/LK Low Conductivity Heater
HT/S	heat sink
HV	high voltage
Hz	hertz
ID	identification
IN	input
INCR	increase
IND	indication
INHIB	inhibit
INIT	initiate
INST	instrument
INSUL	insulation
INT	internal
K	Kelvin
kc	kilocycles
kHz	kilohertz
kV	kilovolts
LAT	latitude
LBR	low bit rate
LECPA	Low-Energy Curved Plate Analyzer (a component of SIDE)
LIM	limit
LM	Lunar Module
LO	low
LONG	longitude
L/O	local oscillator
LOS	loss of signal
LP	long period (PSE sensors)
LSB	least significant bit
LSD	least significant data
LSM	Lunar Surface Magnetometer
LVL	level

mA	milliampere
mAdc	milliamperes dc
MAP	message acceptance pulse
MAX	maximum
Mc	megacycle
MCC	Mission Control Center
MDE	mode
MEAS	measurement
MeV	million electron volts
MHz	megahertz
MIN	minimum
MOCR	Mission Operations Control Room
MOD	module
MODE	operating modes are defined as follows: <u>For HFE</u> MODE/G gradient mode MODE/HK high conductivity mode MODE/LK low conductivity mode
ms	millisecond
MSB	most significant bit
MSD	most significant data
MSFN	Manned Space Flight Network
MTR	motor; on PSE, the three motors are MTRX, MTRY, and MTRZ
MUX	multiplex
mV	millivolts
mW/cm ²	milliwatts per square centimeter
NA	nanoamperes
N/A	not applicable
NEG	negative
NORM	normal
NRZC	Non-Return to Zero Type C (Change)
OPER	operate
O/S	offset
OSC	oscillator
O/T	one-time
OUT	output
PA	power amplifier
pA	picoamperes
PCM	pulse code modulation
PCT	percent
PCU	Power Conditioning Unit
PDR	power dissipation resistor
PDU	Power Distribution Unit
PET	package elapsed time
PHYS	physical; on CPE used as follows: PHYS/AN Physical Analyzer (sensor assembly)
PKG	package

PL plane
 PLT plate
 PM phase modulation
 POS positive
 POSN position
 PRE/LIM pre-limiting
 PRE/REG pre-regulator (a component of the SIDE power supply)
 PRI primary; on ALSEP used as follows:
 PRI/ST primary structure
 P/S power supply
 PSE Passive Seismic Experiment; also:
 PSE/LP long period sensors
 PSE/SP short period sensors
 PSE/LP/SP long and short period sensors
 Long period sensors are further defined as PSE/X, PSE/Y, and PSE/Z while
 PSE/XY denotes the two horizontal long period sensors
 PWR power

R resistor (used as R1 and R2)
 RCVD received
 RCVR receiver
 RDT ring sensor delta temperature (HFE)
 REF reference
 REG regulator (also used as "register" on ALSEP)
 REV reverse
 RF radio frequency
 RLY relay
 R/S remote site
 RST reset
 RT rate (as in BIT RT, CNT RT, etc.)
 RT ring sensor ambient temperatures (HFE)
 RTC real-time command
 RTG Radioisotope Thermoelectric Generator

SCI scientific
 SEC second
 SEL select
 SEQ sequence, sequential; used on HFE as:
 SEQ/FUL Full Sequence
 SEQ/P1 Probe 1 Sequence
 SEQ/P2 Probe 2 Sequence
 Used on ASE as:
 SEQ/S Sequential Single

SEQ scientific equipment
 SIDE Suprathermal Ion Detector Experiment; also:
 SIDE/A } analog and digital voltages
 SIDE/D } or readings
 SIDE/HE high-energy analog data
 SIDE/LE low-energy analog data
 SIDE/LHE least significant high-energy digital data
 SIDE/LLE least significant low-energy digital data

SIDE/MHE most significant high-energy digital data
 SIDE/MLE most significant low-energy digital data

SIG signal
 SLA Spacecraft Lunar Module Adapter
 SNSR sensor
 SP short period (PSE sensor)
 SPST single pole single throw
 STA status
 STBY standby
 S/S samples per second, signal strength
 SWS Solar Wind Spectrometer
 SYNC synchronization
 SW switch
 SUP supply
 SYS system

T temperature (also used as "thermal" on ALSEP)
 TC thermocouple (on HFE, four cable ambient temperatures are read on each probe)
 TEMP temperature
 THERM thermal
 TM telemetry

UHT Universal Handling Tool
 USB unified S-band

V volts, velocity (used to indicate "speed" on PSE in "LVL DIR/V")
 Vac volts ac
 Vdc volts dc
 VCO voltage controlled oscillator
 V/FILT Velocity Filter, a component of SIDE

W watts
 W1, W2, W3 wall locations of structure temperature sensors

XMTR transmitter
 XTAL crystal
 XYZ } axes of LSM, where XYO indicates
 XYO } X, or Y, or neither

∅ phase

1.2 DRAWING SYMBOL STANDARDS

1.2.1 GENERAL DRAWING INFORMATION

A. ZONE REFERENCE

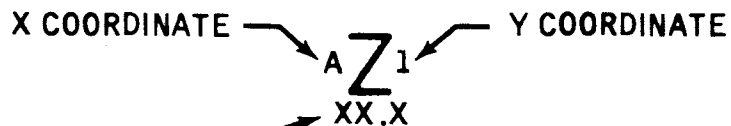

WHEN THIS NUMBER APPEARS IT REFERS TO ANOTHER DRAWING. WHEN THERE IS NO NUMBER THE ZONE REFERS TO ANOTHER AREA ON THE SAME DRAWING.

B. POWER INTRA-DRAWING ZONE REFERENCE

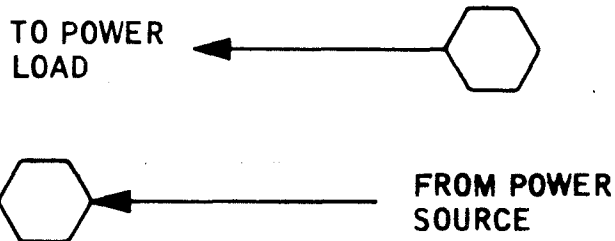

C. SYSTEM INTERCONNECT

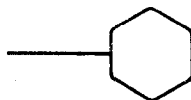

D. DRAWING NOTE REFERENCE



ALSEP 1

1.2.2 LINE LEGEND

A. RF CABLE

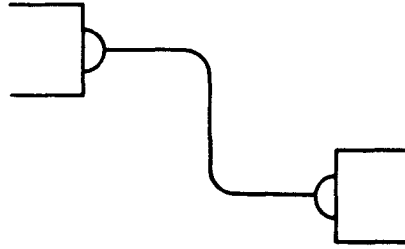

B. ELECTRICAL LINE, POWER AND CONTROL



1. ELECTRICAL, CONNECTED

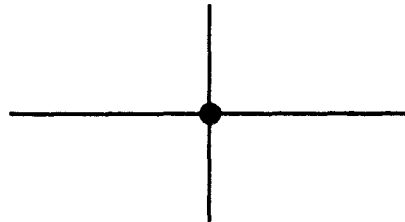

2. ELECTRICAL, CROSSOVER

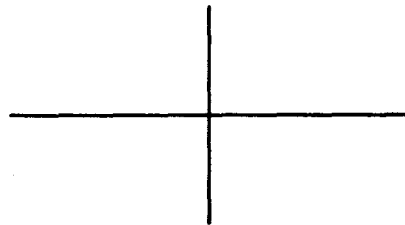

C. DIRECTIONAL FLOW ARROWS



D. COMPONENT ENCLOSURES (TYPICAL)

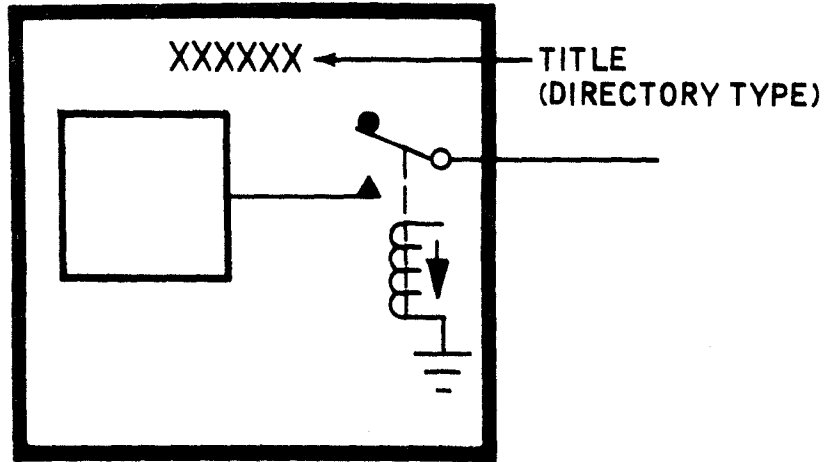

- 1. MAIN ENCLOSURE —————
1/16-INCH SOLID BLACK LINE
- 2. SUB ENCLOSURE —————
1/32-INCH SOLID BLACK LINE
- 3. COMPONENT ENCLOSURE WITH CREW (MANUAL CONTROL) - - - - -
1/16-INCH DASHED BLACK LINE
- 4. EXPERIMENT INTERFACE - - - - -
1/8-INCH DASHED BLACK LINE

EXPERIMENT **ALSEP**

E. MECHANICAL LINKAGE



F. TIMING PULSES

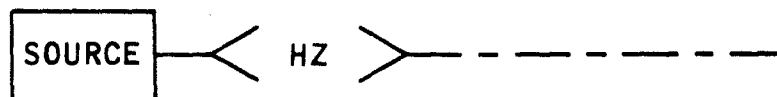

G. TWO-UNIT INTERFACE

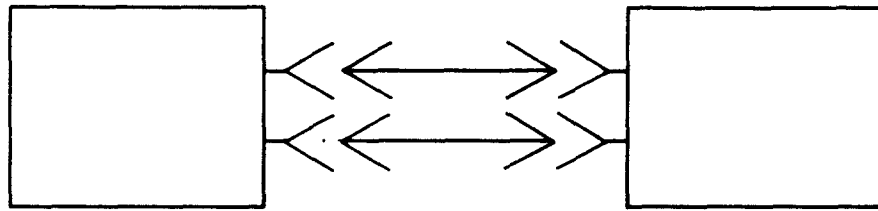

1.2.3 TELEMETRY SYMBOLS

A. MEASUREMENTS TELEMETERED

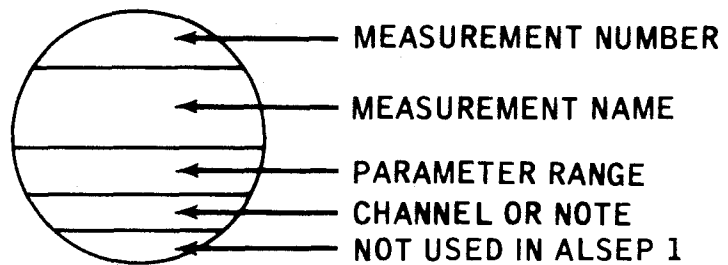

B. METERS

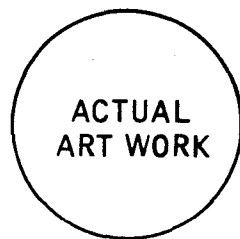

C. SINGLE SOURCE SENSOR

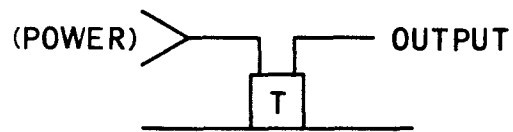

D. COMMANDS

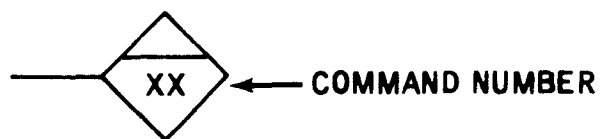

1.2.4 ELECTRICAL SYMBOLS

A. SWITCHES

1. MOMENTARY CONTACT



2. LATCHING CONTACT

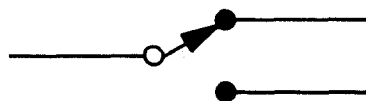

3. SOLID PUSHBUTTON

(PUSH TO OPEN)

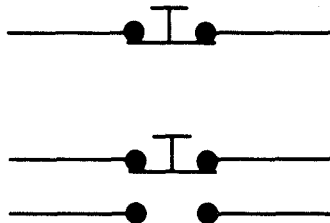

B. FUSES

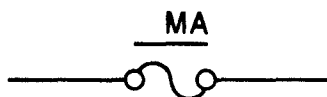

C. RELAYS

1. MOMENTARY CONTACTS

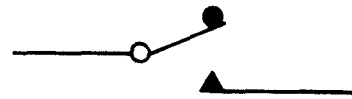

2. LATCHING CONTACTS

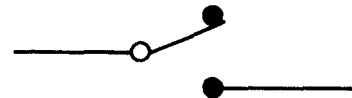

3. NON-LATCHING RELAY SHOWN IN DE-ENERGIZED POSITION

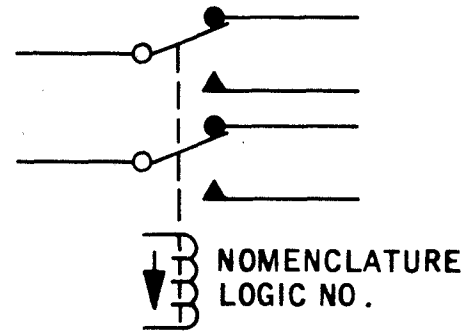

4. LATCHING RELAY

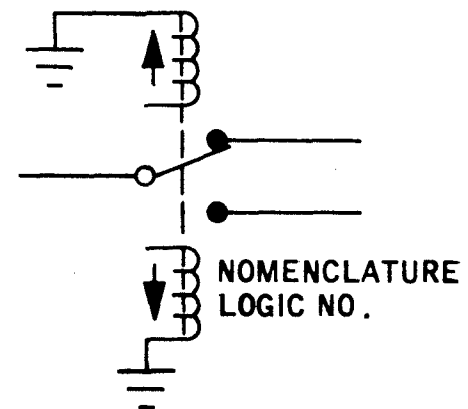

D. RELAY OR SOLENOID DRIVER

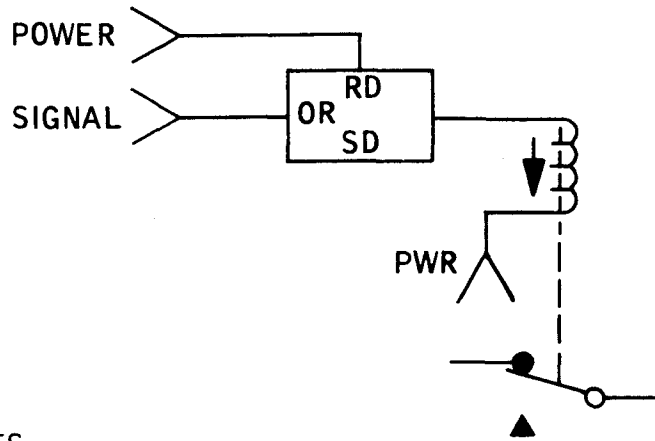

E. BUSES

1. SYMBOL (LENGTH MAY VARY)

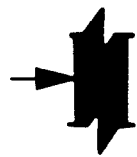

BUS FEED



BUS OUTPUT



NEG BUS

2. DESIGNATION



F. GROUNDS

1. SYSTEM

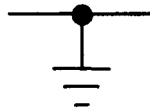

2. FLOATING OR CONTROLLED

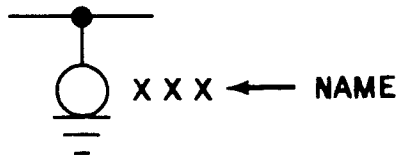

G. TRANSFORMERS

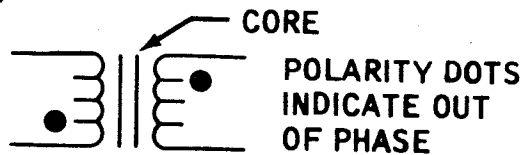

H. CAPACITOR

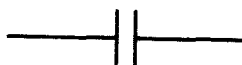

I. DIGITAL INVERTER



J. GATES

1. AND

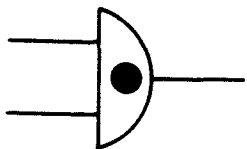

2. NAND

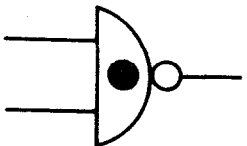

3. OR

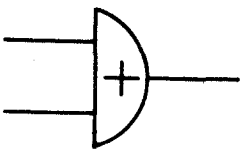

4. NOR

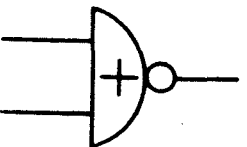

K. TIME DELAY

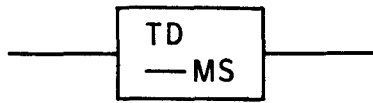

L. ELECTRICAL FILTER



M. MODULATOR



N. DEMODULATOR



O. TRANSISTORS

1. NPN

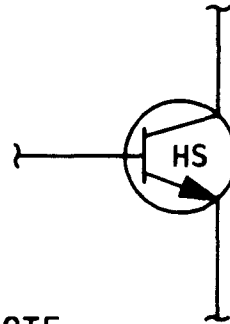

NOTE:
WHEN SHOWN, HS
DENOTES HEAT SINK
MOUNTED.

2. PNP

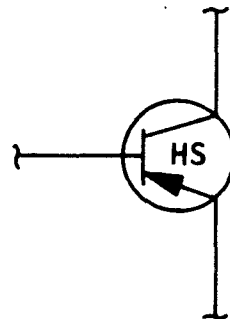

P. NON-AMPLIFYING DEVICE,
IDENTIFIED

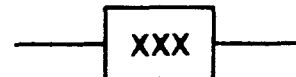

Q. DIODES

1. GENERAL



2. ZENER



3. CONTROL RECTIFIER



R. POTENTIOMETER

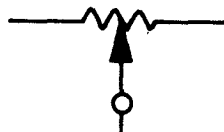

S. HEATER



T. FIXED RESISTOR

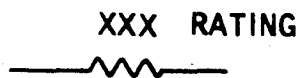

U. THERMISTOR

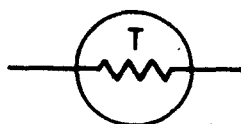

V. THERMOSTAT



W. ANTENNA

NAME
(TYPE OR FUNCTION)



X. PHOTOELECTRIC CELL



Y. AMPLIFIER

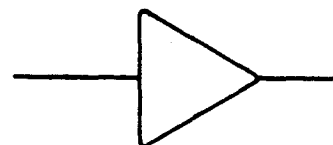
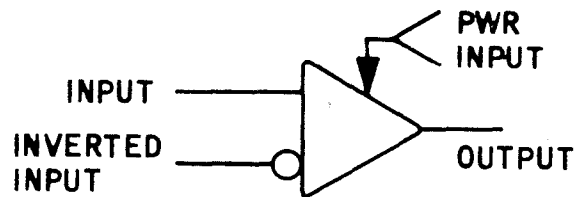

DC, PRE OR BUFFER
AS INDICATED

ALSEP 1

1.2.5 SPECIAL ALSEP SYMBOLS

A. ASTRONAUT SWITCHES

1. ASTRONAUT SWITCH 1

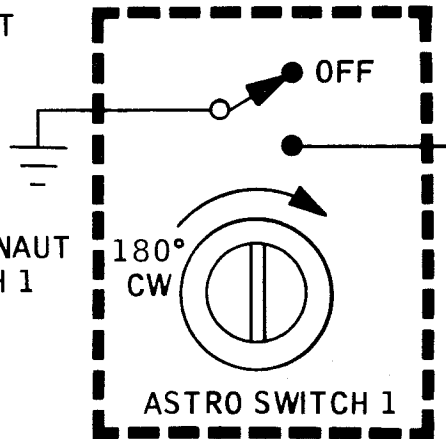

BY-PASSES PCU 1 HOLD OFF CIRCUIT

2. ASTRONAUT SWITCH 2

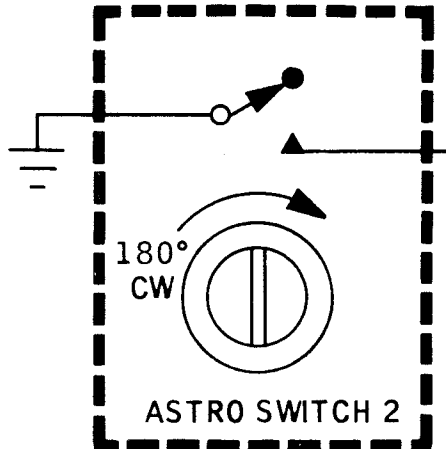

TURNS ON XMTR B, DATA PROCESSOR Y AND RESETS COMMAND RECEIVER CIRCUIT BREAKER

3. ASTRONAUT SWITCH 3

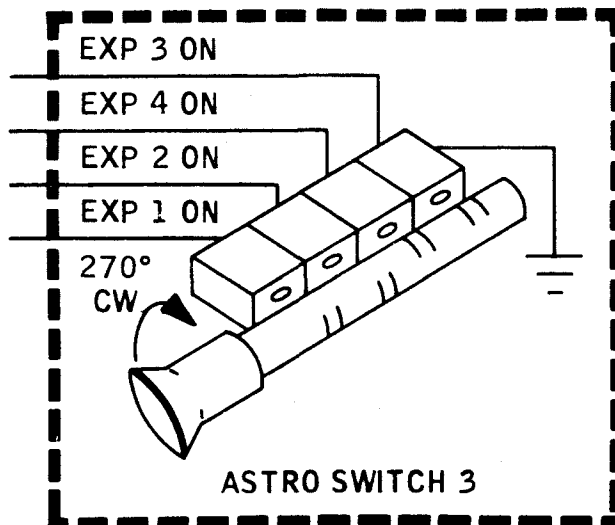

TURNS TO OPERATE, EXP 1 (PSE), EXP 2 (LSM), EXP 4 (SIDE), AND EXP 3 (SWS), IN THAT ORDER (MOMENTARY CONTACTS)

B. FARADAY CUP (SWS SENSOR)

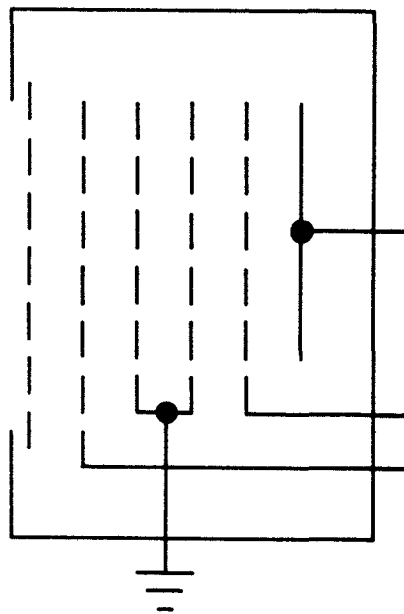

C. GROUND PLANE (USED ON SIDE)

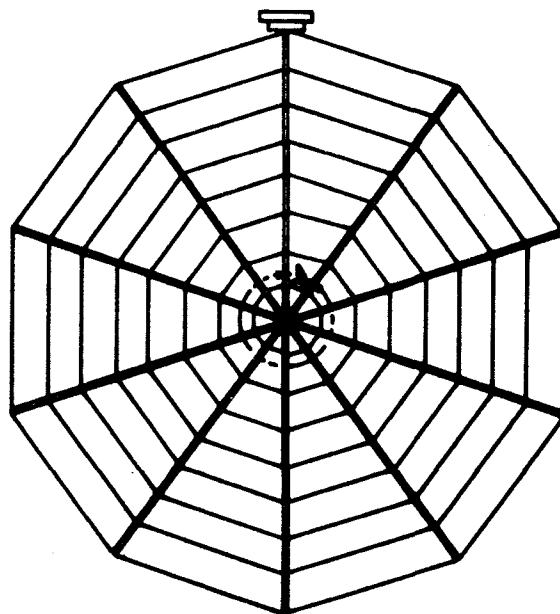

D. SIDE SENSOR ASSEMBLY

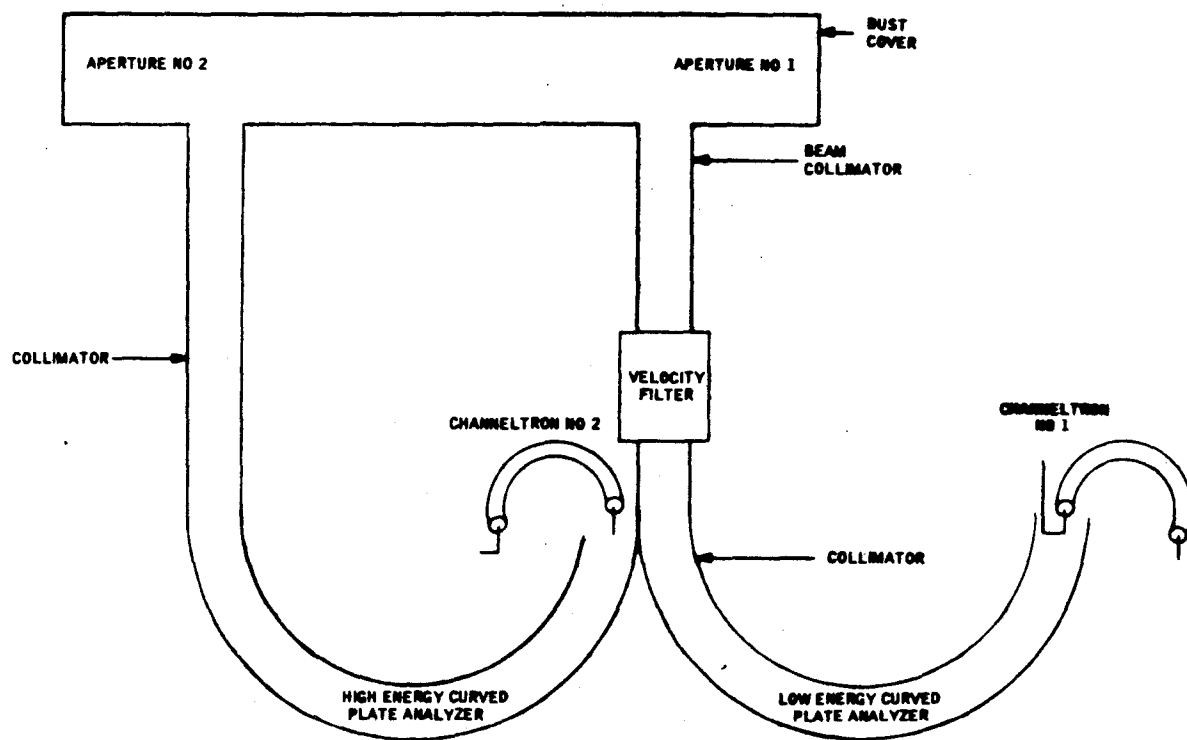

E. COLD CATHODE ION GAGE

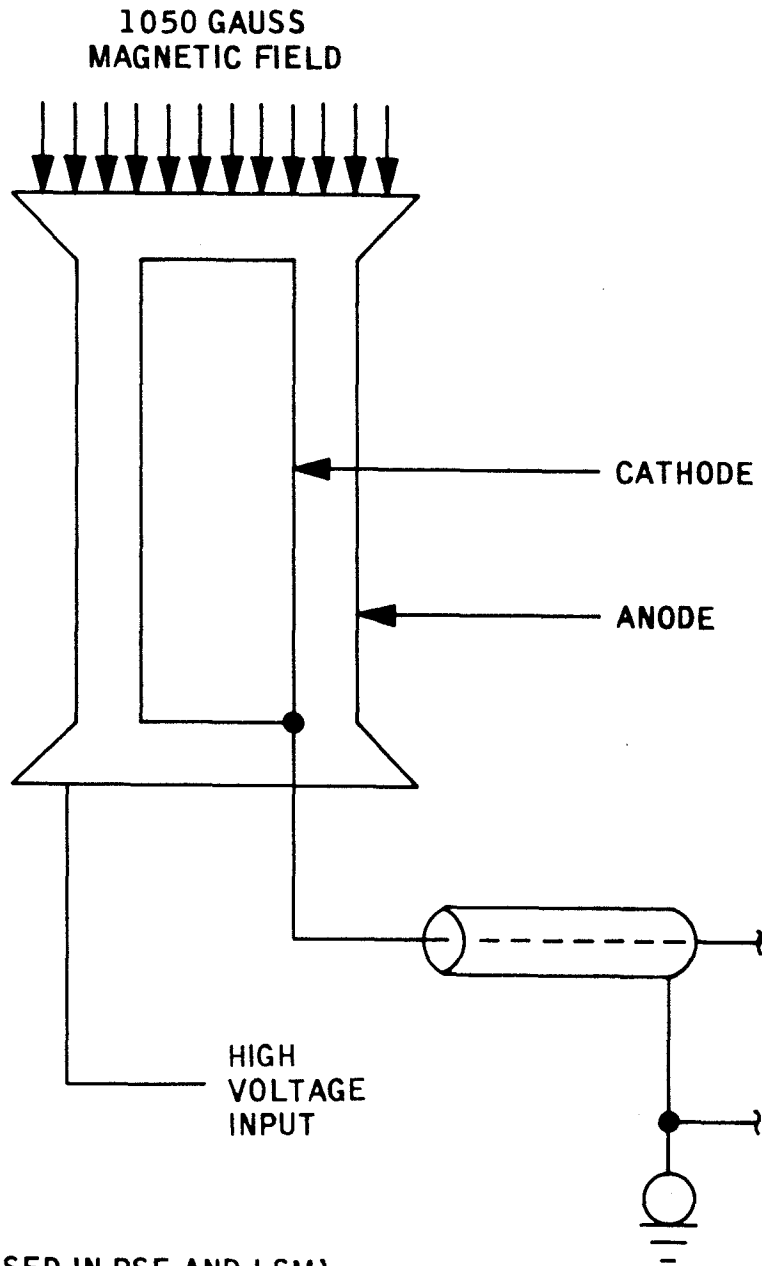

F. MOTOR (USED IN PSE AND LSM)

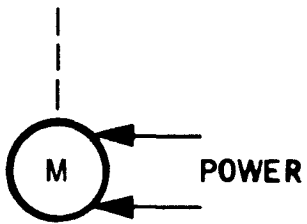

**2 GENERAL
DESCRIPTION**

SECTION 2

GENERAL DESCRIPTION

2.1

ALSEP DESCRIPTION

The Apollo Lunar Surface Experiments Package (ALSEP) system consists of a set of scientific instruments to be placed on the moon's surface by the Apollo flight crew. These instruments will remain on the moon to collect and transmit data for approximately two years. For self-sufficient operations, the ALSEP system includes a nuclear power supply, mechanical support, thermal protection, and data handling equipment. These supporting subsystems provide a flexible central station containing the electrical power, command, telemetry, and structural/thermal subsystems to operate with various combinations of the following scientific experiment subsystems: Passive Seismic, Active Seismic, Magnetometer, Solar Wind Spectrometer, Suprathermal Ion Detector/Cold Cathode Gage, Heat Flow, Charged-Particle Lunar Environment, and Cold Cathode Gage. Weight and volume restrictions of the Lunar Module preclude carrying all eight experiment subsystems on any one flight. This ALSEP Systems Handbook deals with the ALSEP 1 package containing the PSE, LSM, SWS, and SIDE/CCGE (Figure 2-1).

ALSEP 1

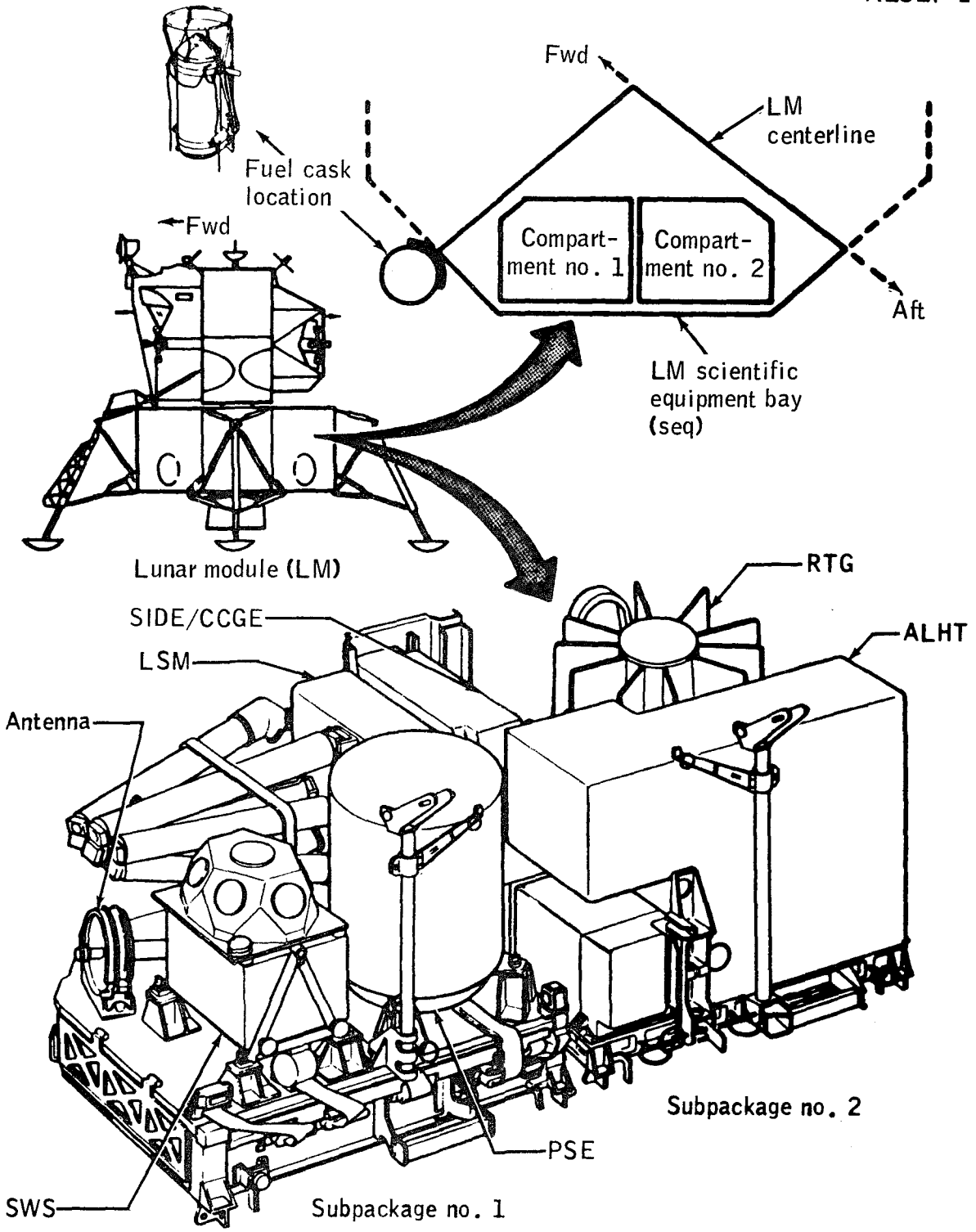
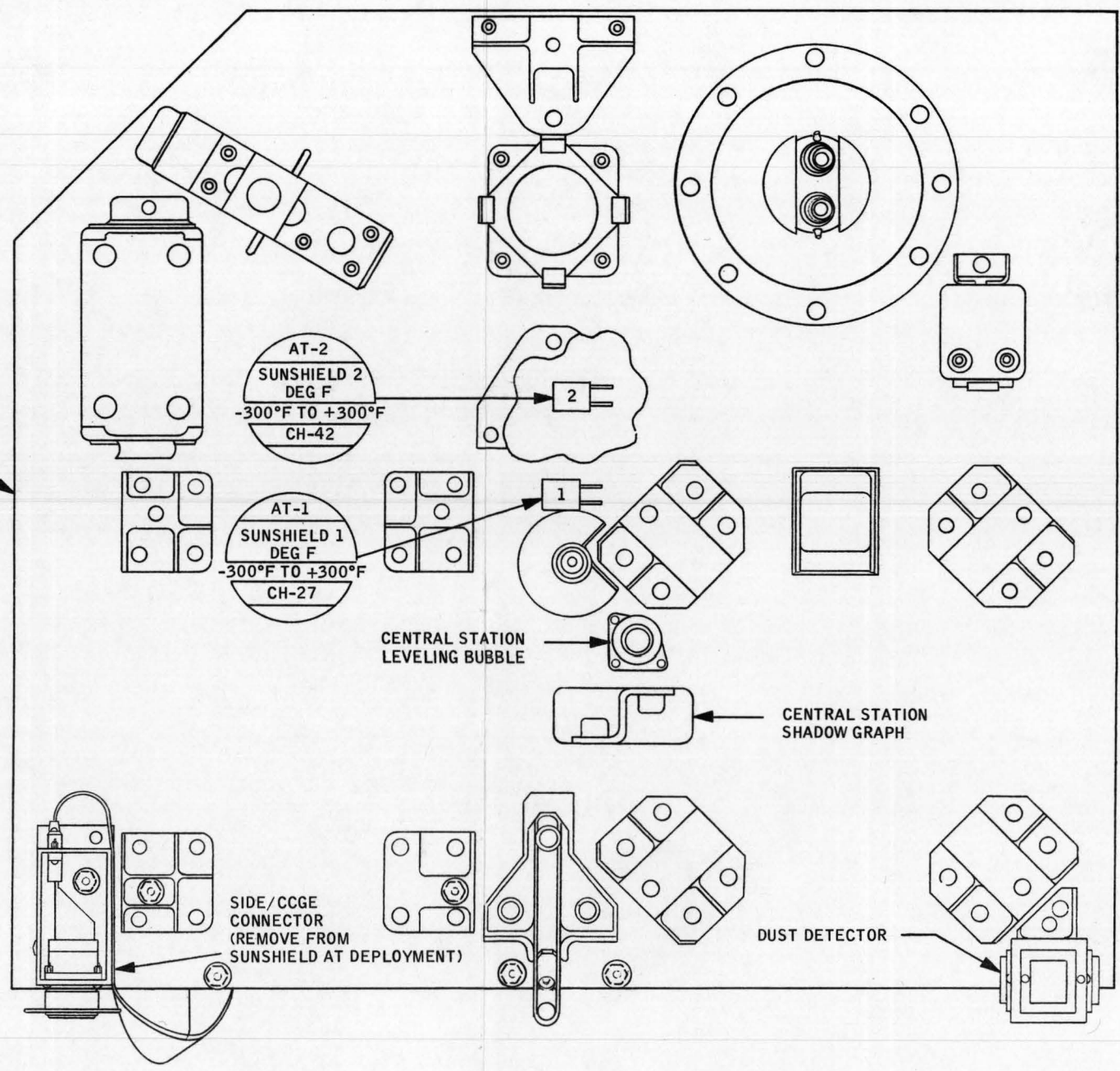
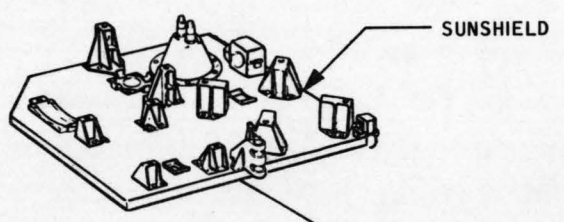

Figure 2-1.- ALSEP/LM interface.

**3 STRUCTURAL
THERM CONTROL
SUBSYSTEM**

LTR	DR	ENGR	DATE	APPROVAL



SIGNATURES		DATE	NATIONAL AERONAUTICS & SPACE ADMINISTRATION MANNED SPACECRAFT CENTER • HOUSTON, TEXAS	
DR	<i>Ed Stearns</i>	1-9-69	SUNSHIELD	
DSGN	<i>Walter</i>	2/1/69		
QC	<i>W. J. ...</i>	2-11-69		
ENGR	<i>George ...</i>	3-21-69		
APP	<i>Ed Stearns</i>	4-2-69	ALSEP I SIZE C DWG NO 3.1	
FEC	<i>W. J. ...</i>	4-2-69		
AUTH	<i>Wm Prang</i>	4-1-69		
55.9 PERCENT			22 X 17	PAGE 3-1 SHEET 0F

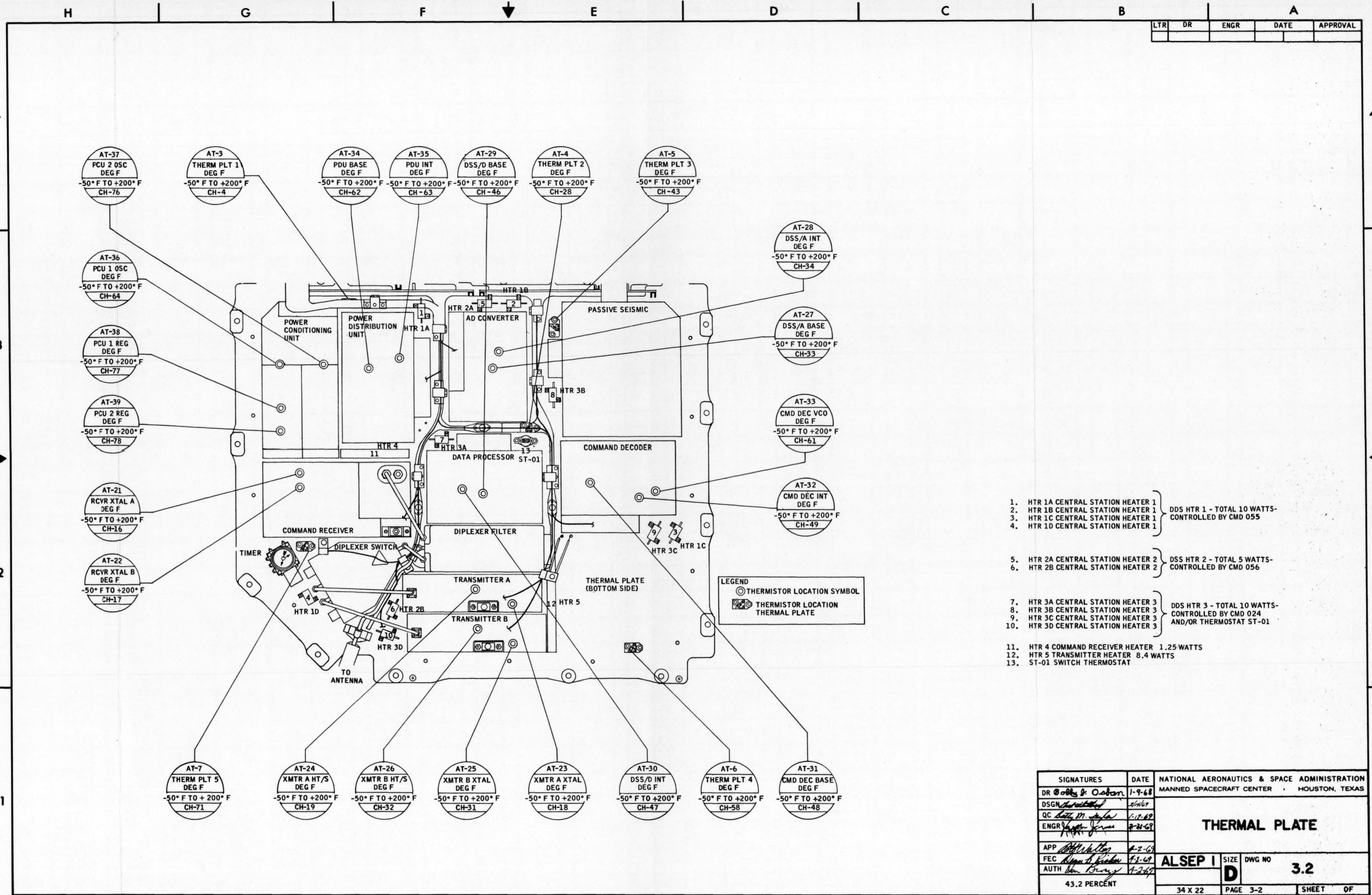

LTR	DR	ENGR	DATE	APPROVAL

1. HTR 1A CENTRAL STATION HEATER 1
 2. HTR 1B CENTRAL STATION HEATER 1
 3. HTR 1C CENTRAL STATION HEATER 1
 4. HTR 1D CENTRAL STATION HEATER 1
- DDS HTR 1 - TOTAL 10 WATTS-
CONTROLLED BY CMD 055
5. HTR 2A CENTRAL STATION HEATER 2
 6. HTR 2B CENTRAL STATION HEATER 2
- DDS HTR 2 - TOTAL 5 WATTS-
CONTROLLED BY CMD 056
7. HTR 3A CENTRAL STATION HEATER 3
 8. HTR 3B CENTRAL STATION HEATER 3
 9. HTR 3C CENTRAL STATION HEATER 3
 10. HTR 3D CENTRAL STATION HEATER 3
- DDS HTR 3 - TOTAL 10 WATTS-
CONTROLLED BY CMD 024
AND/OR THERMOSTAT ST-01
11. HTR 4 COMMAND RECEIVER HEATER 1.25 WATTS
 12. HTR 5 TRANSMITTER HEATER 8.4 WATTS
 13. ST-01 SWITCH THERMOSTAT

LEGEND
 (Symbol) THERMISTOR LOCATION SYMBOL
 (Symbol) THERMISTOR LOCATION THERMAL PLATE

SIGNATURES		DATE	NATIONAL AERONAUTICS & SPACE ADMINISTRATION MANNED SPACECRAFT CENTER HOUSTON, TEXAS	
DR <i>Bob O. Osborn</i>		1-9-68		
DSGN <i>...</i>		1-11-68		
QC <i>...</i>		1-17-68		
ENGR <i>...</i>		2-21-68		
APP <i>...</i>		2-2-68		
FEC <i>...</i>		1-2-68		
AUTH <i>...</i>		1-2-68		
43.2 PERCENT				
ALSEP I		SIZE	DWG NO	
		D	3.2	
34 X 22		PAGE 3-2	SHEET OF	

LYR	DR	ENGR	DATE	APPROVAL

4

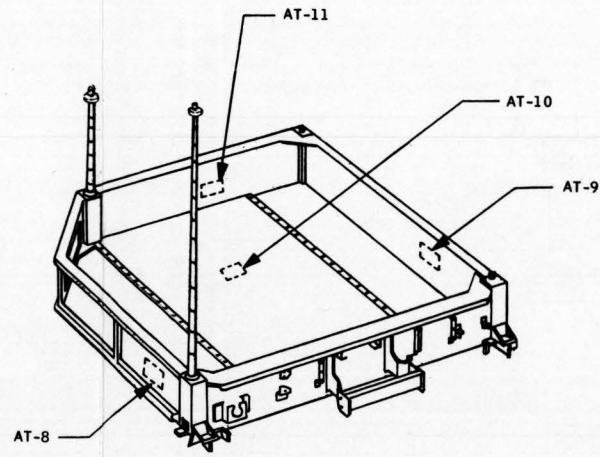

PRIMARY STRUCTURE

3

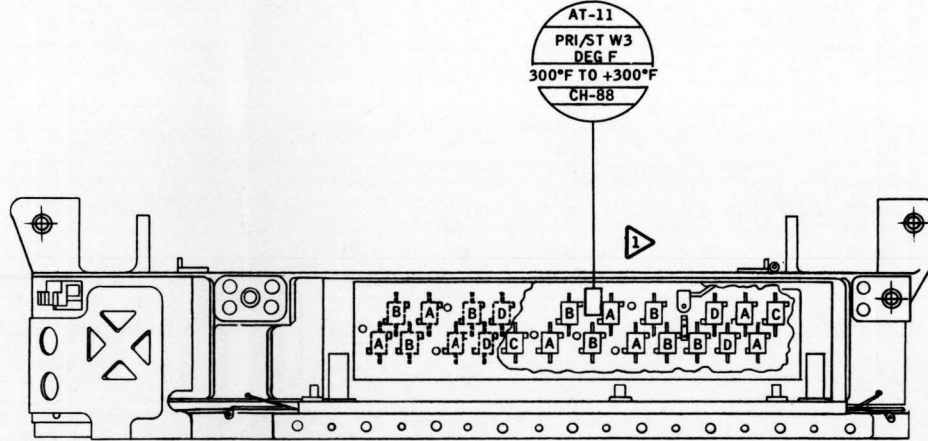

4

2

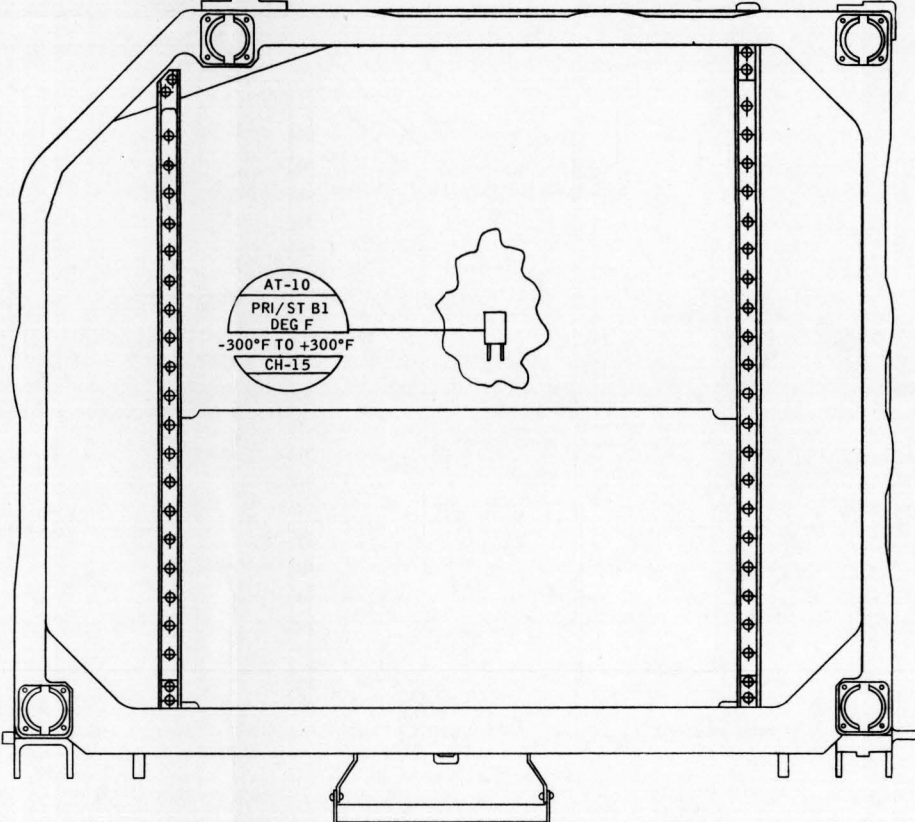
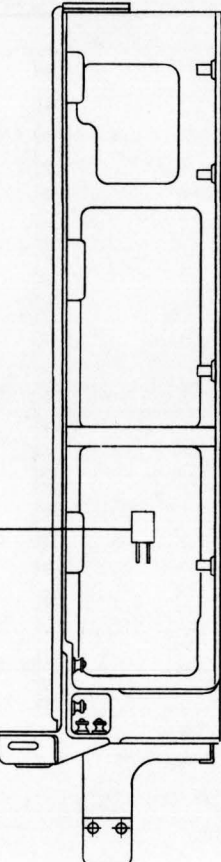

3

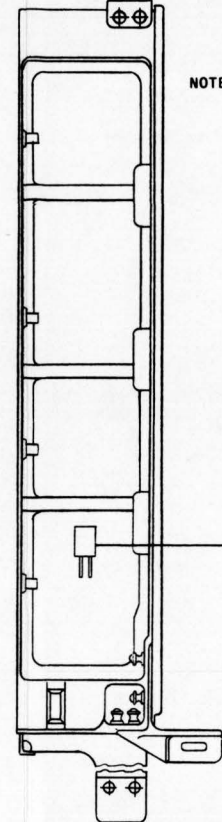

NOTE: RESISTORS MARKED A - SHUNT REGULATOR 1 RESISTORS 3.57 Ω TOTAL
 RESISTORS MARKED B - SHUNT REGULATOR 2 RESISTORS 3.57 Ω TOTAL
 RESISTORS MARKED C - PDR 1 RESISTORS 120 Ω TOTAL 7 WATTS
 RESISTORS MARKED D - PDR 2 RESISTORS 60 Ω TOTAL 14 WATTS

2

1

SIGNATURES		DATE	NATIONAL AERONAUTICS & SPACE ADMINISTRATION	
DR	<i>S. H. H. H.</i>	11/13/60	MANNED SPACECRAFT CENTER - HOUSTON, TEXAS	
DSGN	<i>S. H. H. H.</i>	8/14/60	PRIMARY STRUCTURE	
QC	<i>S. H. H. H.</i>	8-14-60		
ENGR	<i>James James</i>	5-21-69	ALSEP I SIZE DWG NO D 3.3	
APP	<i>S. H. H. H.</i>	8-2-69		
FEC	<i>S. H. H. H.</i>	8-2-69		
AUTH	<i>S. H. H. H.</i>	8-2-69		
43.9 PERCENT			34 X 22	PAGE 3-3 SHEET OF

1



D

C

B

A

LTR	DR	ENGR	DATE	APPROVAL

4

4

3

3

2

2

1

1

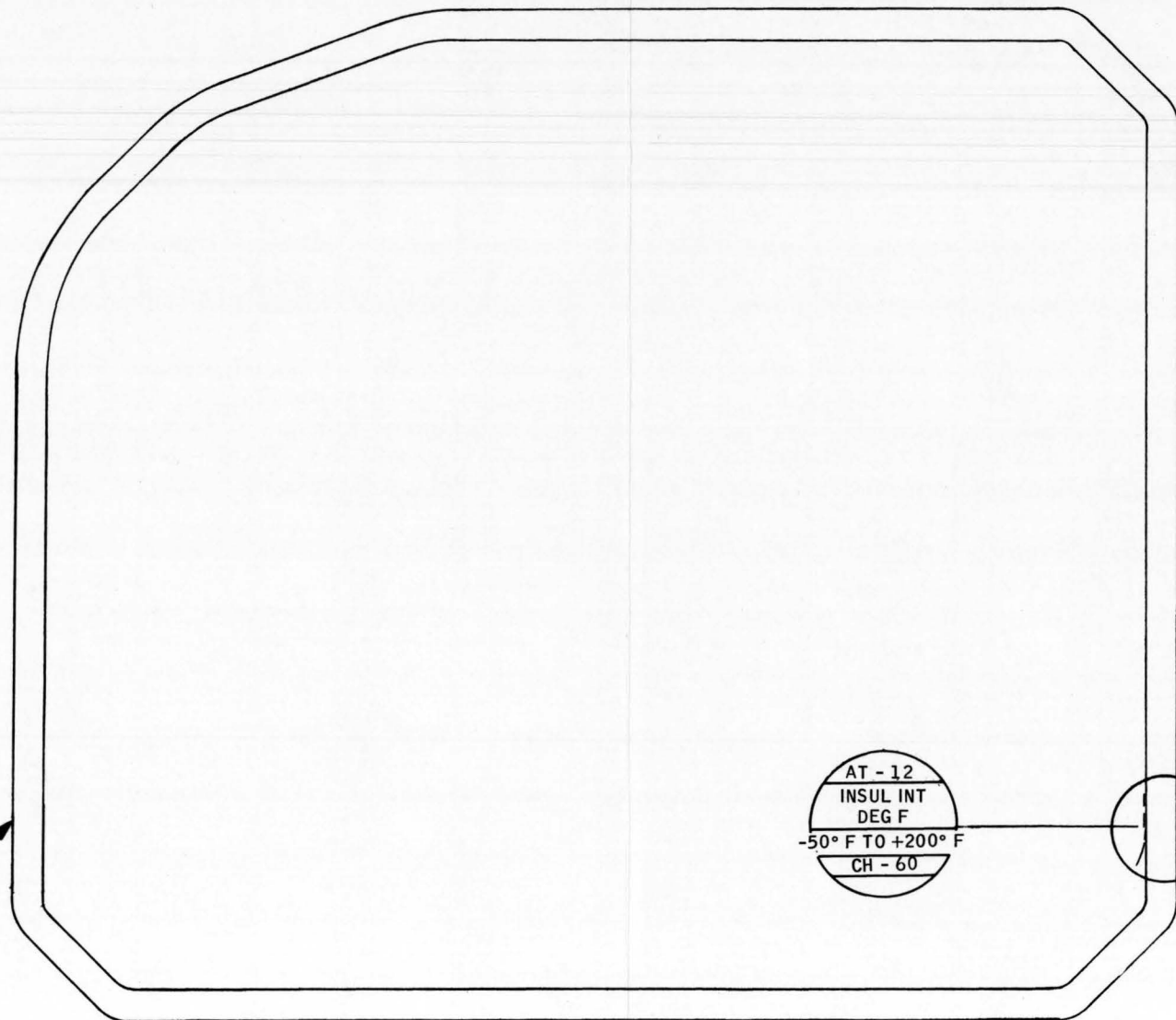

AT - 12
INSUL INT
DEG F
-50° F TO +200° F
CH - 60

AT - 13
INSUL EXT
DEG F
-300° F TO +300° F
CH - 72

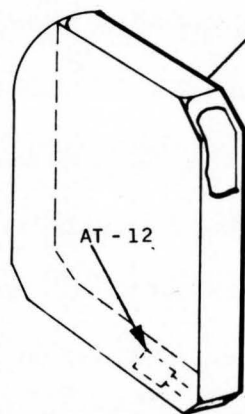

THERMAL BAG

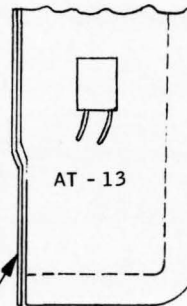

AT - 13

SIGNATURES		DATE	NATIONAL AERONAUTICS & SPACE ADMINISTRATION MANNED SPACECRAFT CENTER • HOUSTON, TEXAS	
DR	<i>H. Johnson</i>	4/8/69	THERMAL BAG	
DSGN	<i>Bill Cornelius</i>	3/29/69		
QC	<i>Wm. M. Jankin</i>	3/26/69		
ENGR	<i>Joseph James</i>	3-21-69		
APP	<i>Bill Walton</i>	4-2-69	ALSEP I SIZE DWG NO C 3.4	
FEC	<i>Don H. Fisher</i>	4-7-69		
AUTH	<i>Don Bray</i>	4-2-69		
55.9 PERCENT			22 X 17	PAGE 3-4 SHEET OF

OUTSIDE THERMAL BAG CENTRAL STATION

REV	BY	ENGR	DATE	APPROVAL

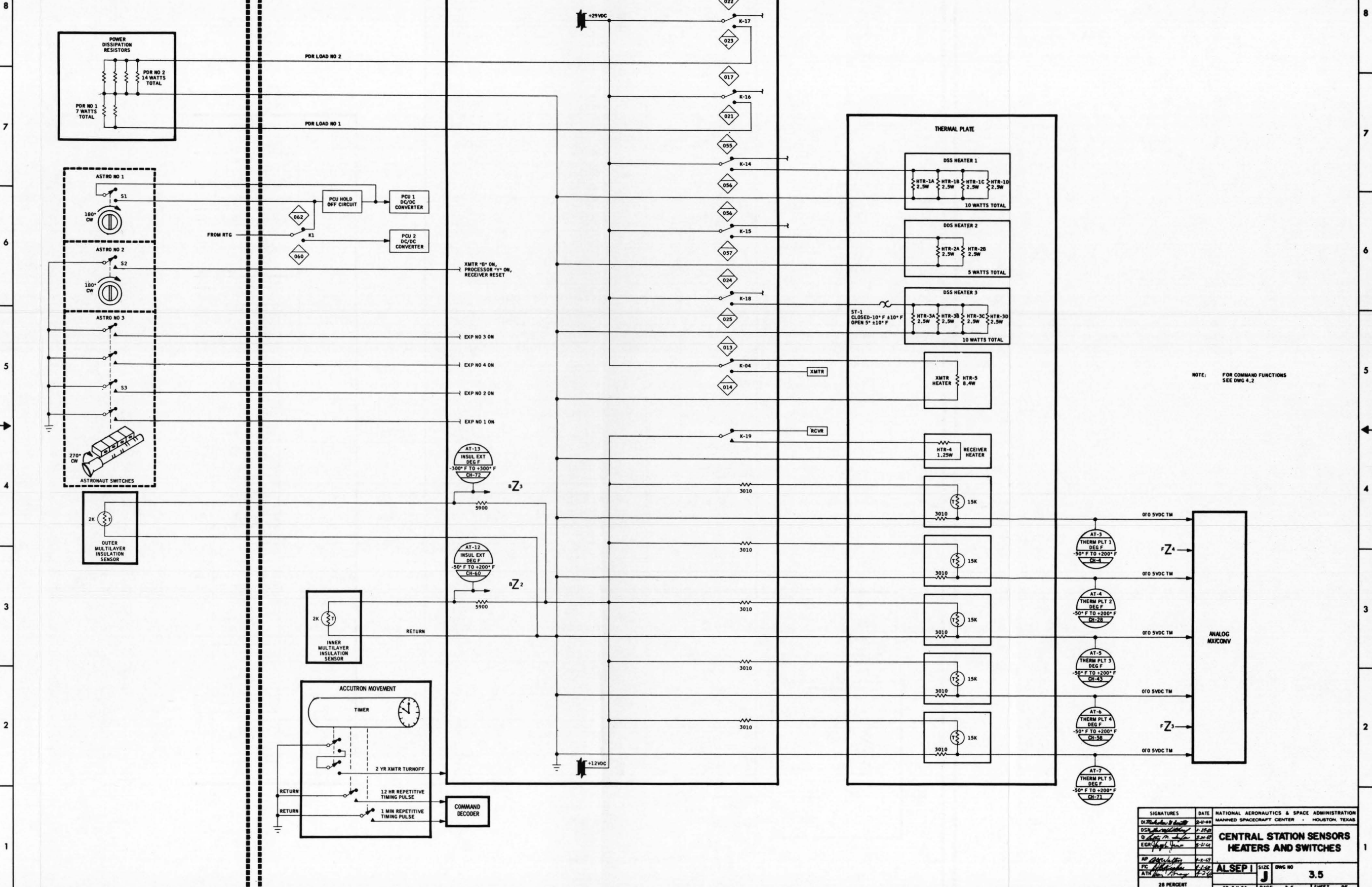

SIGNATURES	DATE	NATIONAL AERONAUTICS & SPACE ADMINISTRATION
DIR	2-11-69	MANAGED SPACECRAFT CENTER HOUSTON, TEXAS
DSM	2-25-69	
EGR	3-20-69	
AP	3-2-69	
PC	3-1-69	
ATR	3-2-69	

**CENTRAL STATION SENSORS
HEATERS AND SWITCHES**

ALSEP I	SIZE J	DWG NO 3.5
28 PERCENT	49.5 X 34	PAGE 3-5 SHEET 0F

4 ELECTRICAL
POWER
SUBSYSTEM

ELECTRICAL POWER SUBSYSTEM

4.1 SYSTEM DESCRIPTION

The electrical power subsystem provides the electrical power for lunar surface operation of the ALSEP. Primary electrical power is developed by thermoelectric action with thermal energy supplied by a radioisotope source. The primary power is converted, regulated, and filtered to provide the six operating voltages for the ALSEP experiment and support subsystems.

The components are a radioisotope thermoelectric generator assembly, a fuel capsule assembly, a power conditioning unit, and a power distribution unit.

4.1.1 Radioisotope Thermoelectric Generator (RTG)

- A. RTG Commands - No command capability.
- B. RTG Telemetry - Four temperatures, one output voltage, and one output current (Tables 6-VIII and 6-X).
- C. Output - 68 watts, nominal.

4.1.2 Power Conditioning Unit (PCU)

The PCU performs three major functions:

- A. Voltage conversion
- B. Voltage regulation
- C. RTG protection

Each power conditioner consists of a dc-to-dc power converter (inverter and rectifiers), which converts the RTG 16-volt input to the six operating voltages, and a shunt current regulator to maintain the output voltages within approximately ± 1 percent. The input voltage is also regulated by this action by maintaining a constant load on the RTG. It is necessary to keep a constant load on the generator to prevent overheating of the thermocouples in the RTG.

The +16 volts from the RTG is applied through the switching circuit to the selected dc-to-dc converter, applying power to the inverter and completing the shunt regulation circuit. Applying power to the inverter permits it to supply ac power to the rectifiers that develop the dc voltages applied to the filters. The outputs from the filters are the six operating voltages applied to the data subsystem. Output and input voltages are regulated by feedback from the +12-volt output to the shunt regulator. The +12-volt feedback is also applied to the switching circuit for over or under voltage determination and switching to the redundant inverter and regulator, if necessary. All the output voltages are regulated by the 12-volt feedback.

4.1.3 Power Distribution Unit (PDU)

The PDU distributes power to experiment and central station subsystems and provides circuit overload protection and power switching of selected circuits. The PDU also provides signal conditioning of selected central station and RTG telemetry monitor signals prior to input to the analog multiplexer for analog-to-digital conversion and subsequent data transmission to earth.

- 4.1.3.1 Power-off sequencer.- (Refer to Figure 4.2.) The power-off sequencer of the PDU detects minimum reserve power and sequentially turns to standby up to three preselected experiments to bring the power reserve within acceptable limits. The minimum reserve power is detected by monitoring the voltage across the shunt regulator transistor. This voltage is applied to an operational amplifier used as a level detector. An RC delay network is employed at the output of the level detector. The output of the delay is applied to a second level detector which drives the power-off sequencer logic. This arrangement turns on the power-off sequencer logic input gate when the reserve power drops below the levels as follows:

Reserve Power to Start Experiment Turn-Off (135 ms Delay):

0.78 watts \pm 0.57 watts

Experiment Turn-Off Sequence, via the Power-Off Sequencer, is as follows:

- A. Experiment #4 (SIDE/CCGE)
- B. Experiment #3 (SWS)
- C. Experiment #1 (PSE)

NOTE

Experiment #2 (LSM) is not
in the turn-off sequence.

The sequencer decoding gates are connected so that upon turn-on of the logic input gate, an output ground level signal is provided during the count between 1 and 9 milliseconds to the SIDE/CCGE power standby relay driver. This relay removes experiment operate power and applies power to the standby line. If the overload persists, the ground level signal supplied to the SIDE/CCGE standby line is removed and a ground level signal is applied to the SWS power standby command input during the next 8-millisecond period (when the count is between 9 and 17 milliseconds). If overloading persists, the sequencer could continue in the same manner until the Passive Seismic Experiment (PSE) is in the standby mode. If, however, the overload is removed within the sequence, the counter will be reset in 2 milliseconds after a satisfactory power reserve signal is obtained, thus stopping the sequence. Note that the power OFF sequencer action places the experiments to standby ON from either an operational ON condition or from a standby OFF condition.

- 4.1.3.2 Temperature sensor circuit.- Operational amplifiers are used to amplify the resistive bridge outputs for the RTG hot and cold junction temperatures. The temperature sensors located on the RTG are platinum wire sensors (Drawing 4.1). Bridge excitation is 12 Vdc on both the hot and cold frame temperature circuits.

Nickel wire temperature sensors are used in dividers to monitor exposed structural temperature, multi-layer bag insulation temperatures, and sunshield temperatures. The circuit is a simple divider consisting of 12 Vdc supplied through 5900 ohms and the sensor to ground. The output analog signal is taken across the sensor, providing a linear response from -300°F to +300°F. (Refer to Section 3 for sensor locations.)

Thermistor sensors are provided to monitor temperatures within the central station and subsystems. The sensor excitation is +12 Vdc. The sensor ranges are between -50°F and +200°F (Drawing 3.2).

- 4.1.3.3 Power control.- (Refer to Drawing 4.2) Power control is provided by ground commands and/or astronaut switch functions causing the command lines to go to ground potential, thus actuating relay drivers and their associated relays.

Four transistorized relay drivers, magnetic latching relays, and one magnetic latching relay acting as an overload sensor (circuit breaker) perform the control and circuit protection function for each experiment. The experiment standby power line is fused at 500 mA. Three command inputs are provided for each experiment power control circuit.

- A. Experiment Operate Select command
- B. Experiment Standby Select command
- C. Experiment Standby OFF command

The three command inputs operate one or both of two power switching relays. One relay provides the selection of either standby power or operational power. The other interrupts the standby power line. The receipt of an Experiment Operate Select command will transfer the relay to a position which provides power through the current sensing coil of the circuit breaker relay to the experiment electronics. A second command, Standby OFF, operates the relay coil of the standby power interruption relay to open the circuit supplying power to the standby line. The Standby Select command, however, operates on both relays. The Standby Select command actuates both relays to the positions that supply power to the standby line. To place an experiment from OPERATE to standby OFF, the Standby Select command must be executed prior to the standby OFF command. DSS Htr 1 and DSS Htr 2 power control operates similar to experiment power control.

D

C

B

A

4

4

3

3

2

2

1

1

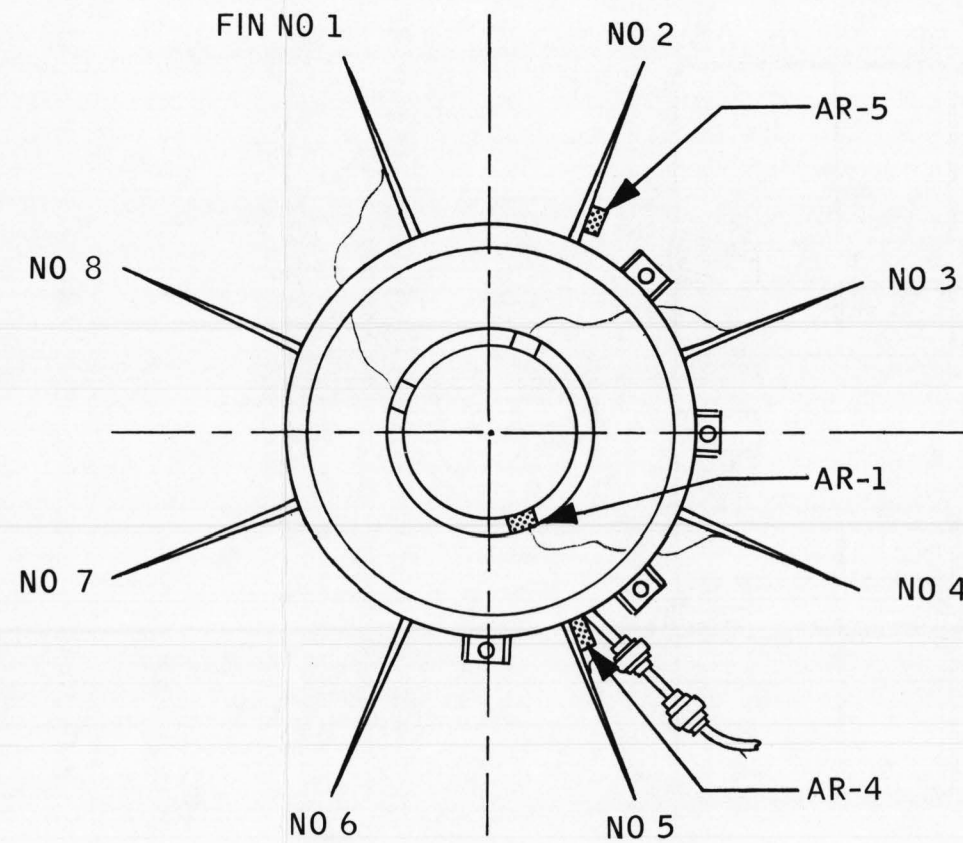

TOP VIEW

TM
DESIGNATIONS

- AR-1
- AR-4
- AR-5

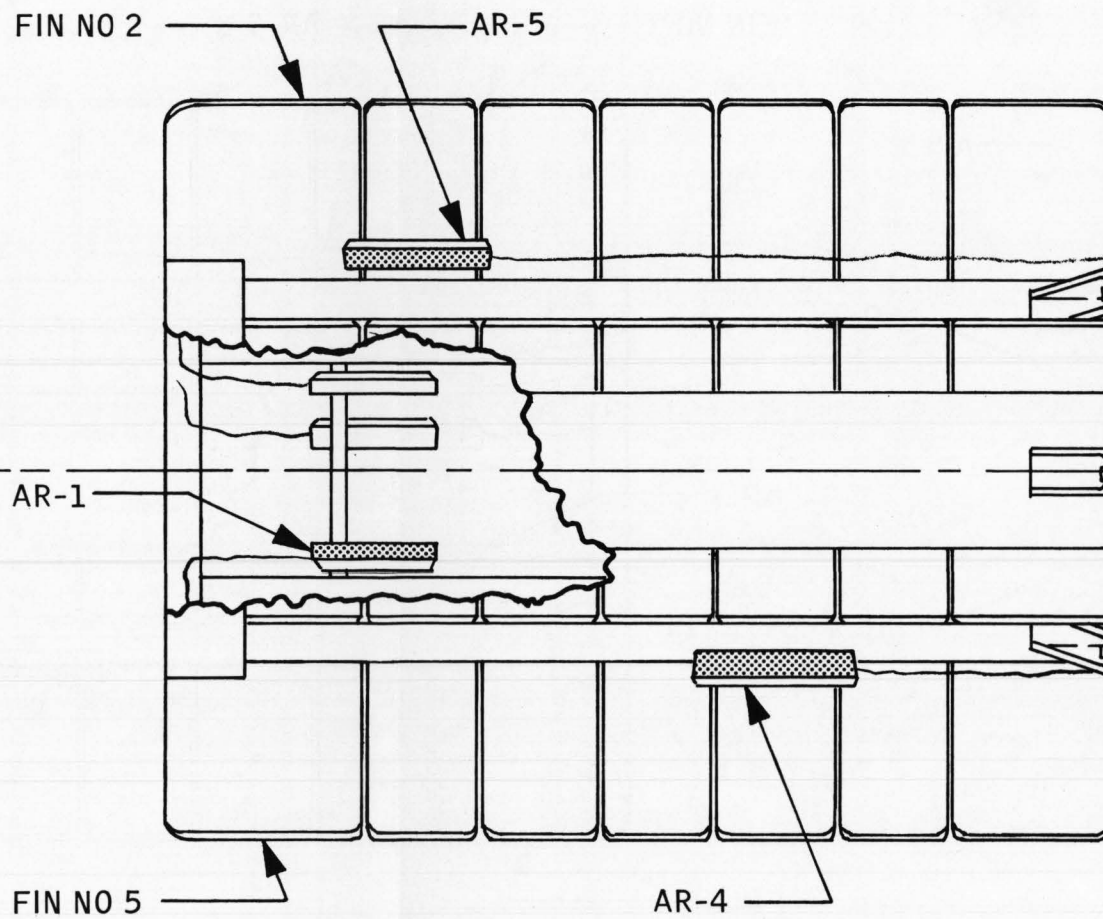

SIDE VIEW

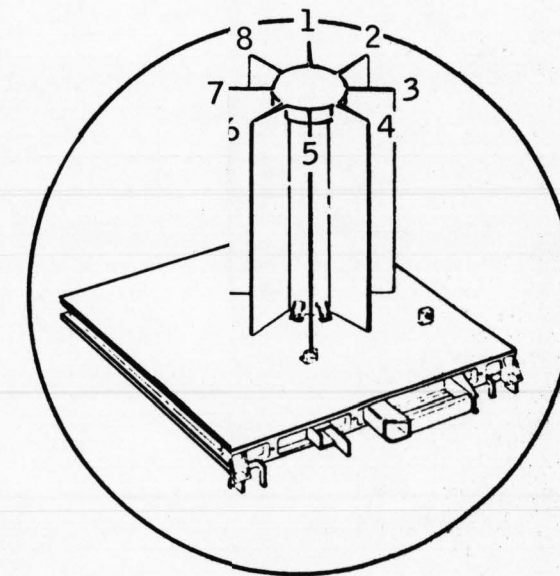

SIGNATURES		DATE	NATIONAL AERONAUTICS & SPACE ADMINISTRATION		
DR	<i>Bob Sherrill</i>	1-14-69	MANNED SPACECRAFT CENTER • HOUSTON, TEXAS		
DSGN	<i>and others</i>	2-14-69	RTG TEMPERATURE SENSOR LOCATIONS		
QC	<i>Betty M. Taylor</i>	2-14-69			
ENGR	<i>John Taylor</i>	3-2-69			
APP	<i>Bob Walton</i>	4-2-69			
FEC	<i>Bob Fisher</i>	4-2-69	ALSEP 1	SIZE B	DWC NO. 4.1
AUTH	<i>Don Bray</i>	4-2-69			
86.5 PERCENT			17 X 11	PAGE 4-3	SHEET OF

TRANSMITTER POWER CONTROL

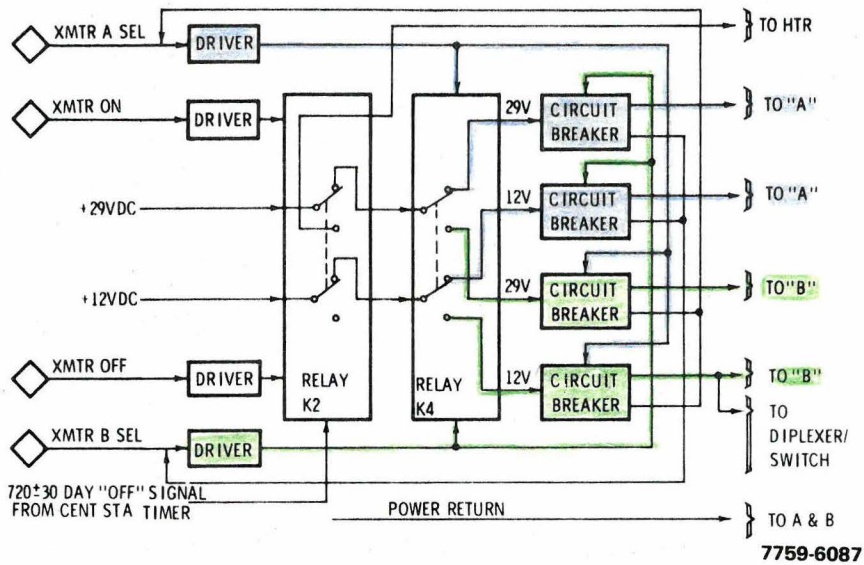

DATA PROCESSOR & CMD RCVR PWR CONTROL CKTS

DATA PROCESSOR

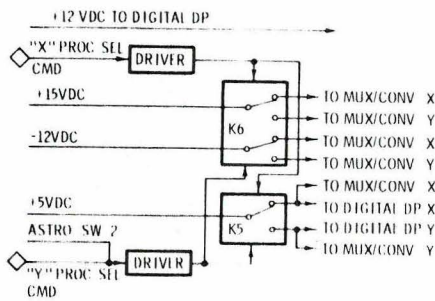

COMMAND RECEIVER

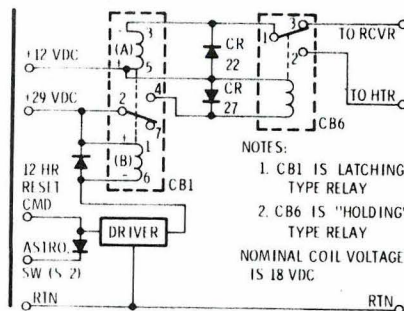

7759-6088

11-56

W1704.2

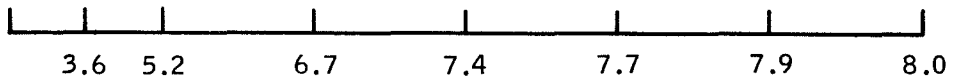
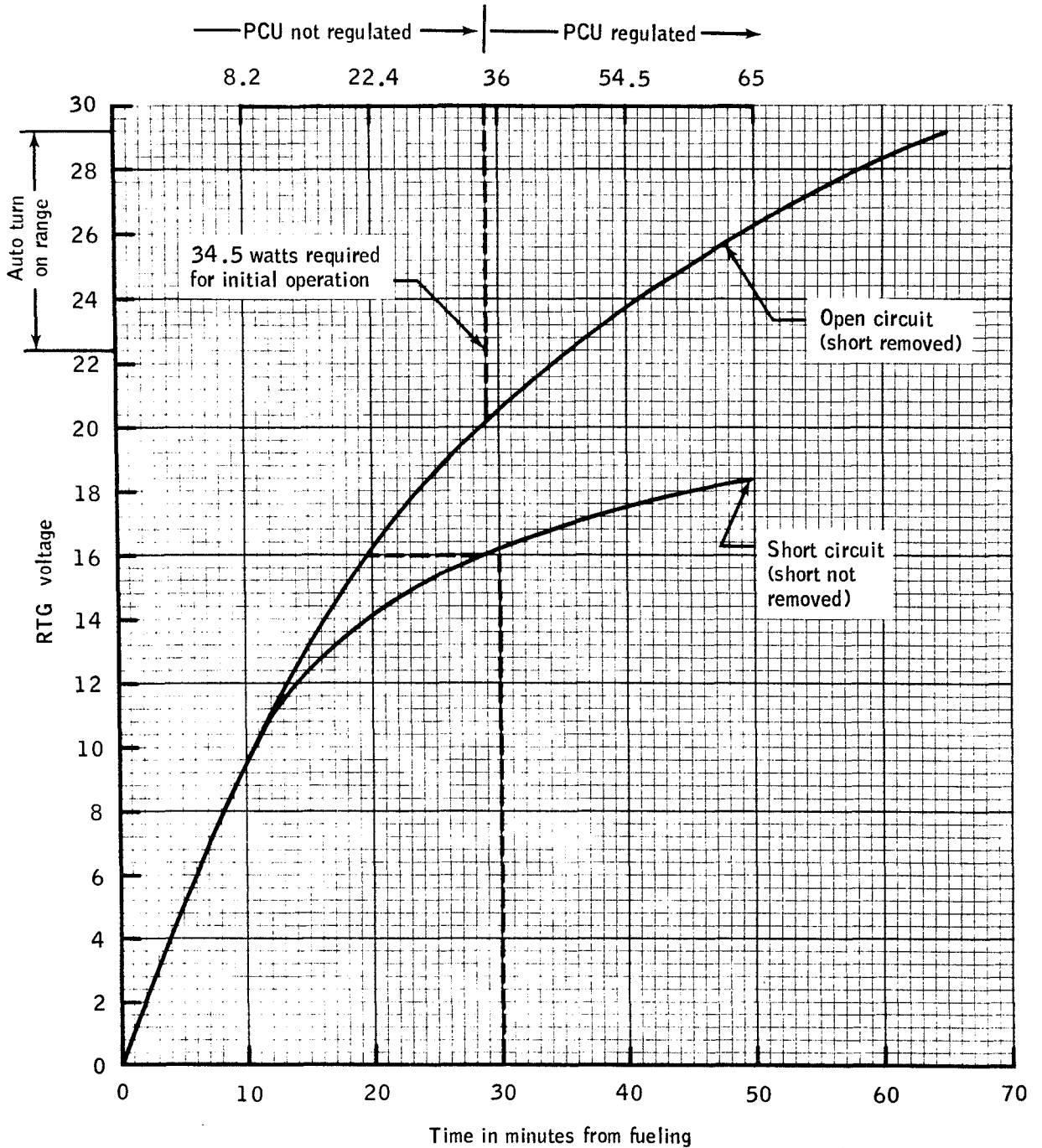

Example:

Short removed 30 minutes after fueling. Move horizontally from short circuit curve to open circuit curve. If Astronaut switch no. 1 is actuated 9 minutes later, the required 34.5 watts will be available

Figure 4-1.- RTG warmup characteristics.

4-5

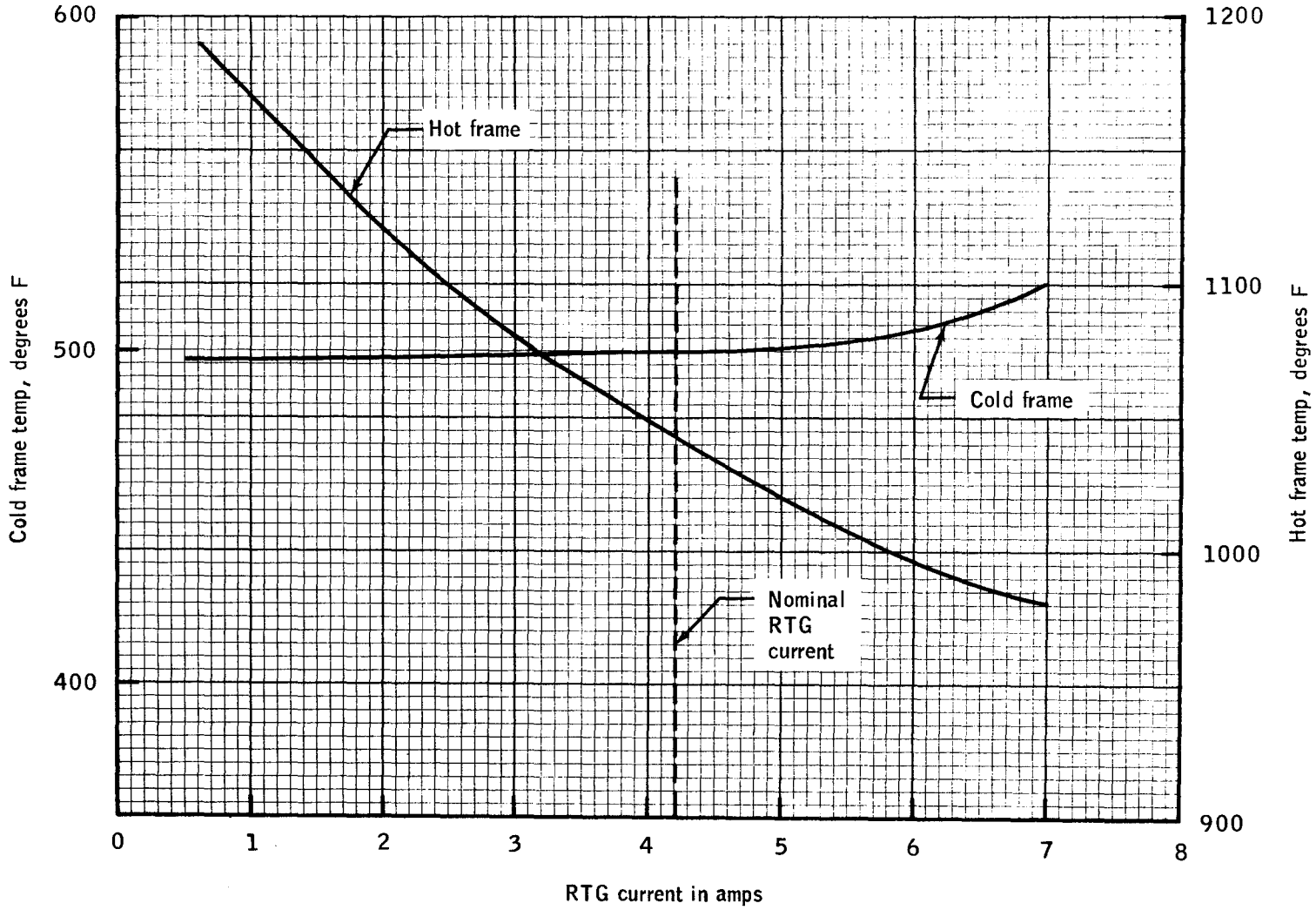

Figure 4-2.- RTG hot and cold frame temps vs RTG current.

ALSEP 1

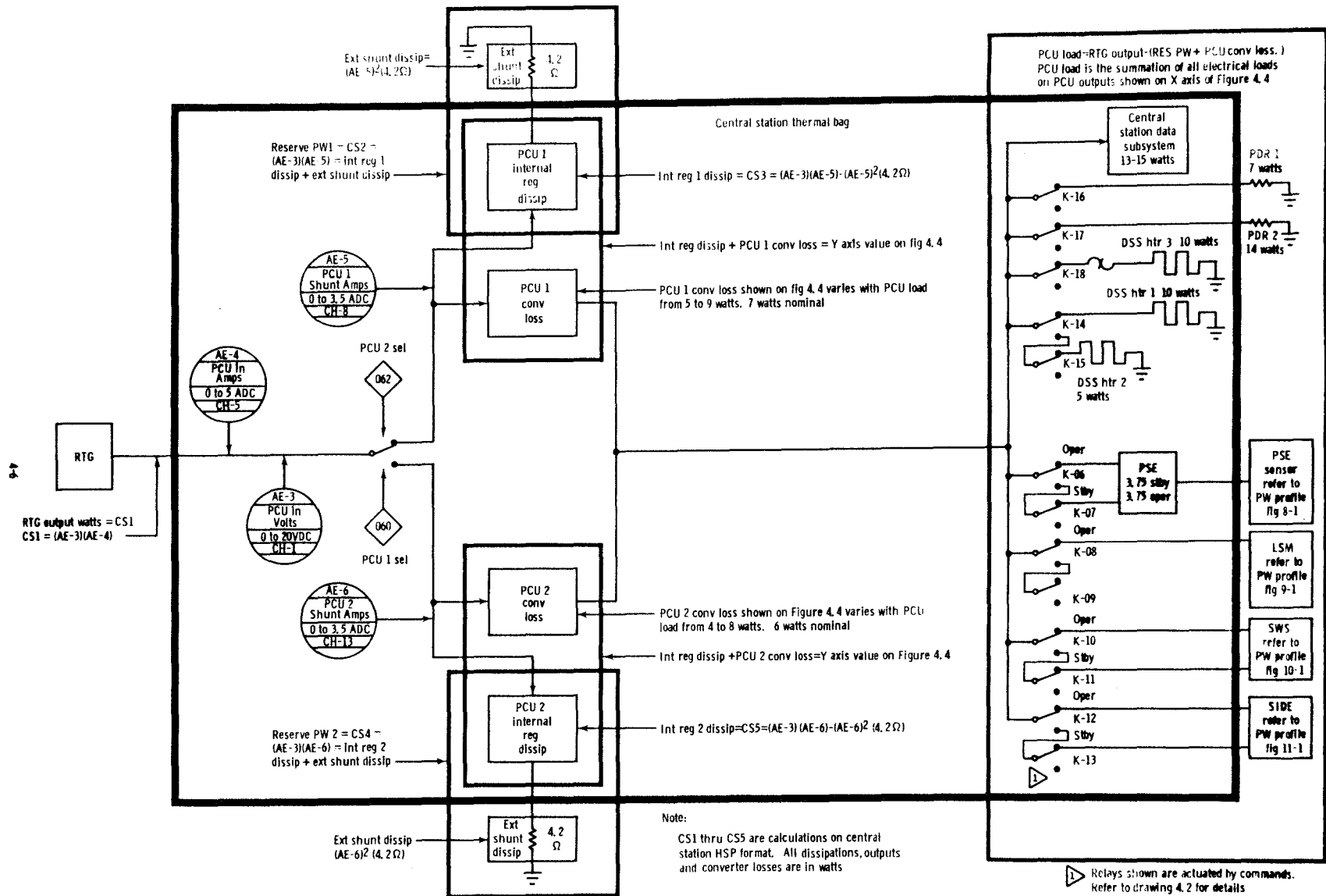

Figure 4-3. - ALSEP 1 power dissipation distribution.

Dissipation within PCU vs PCU output power
55 watt regulator

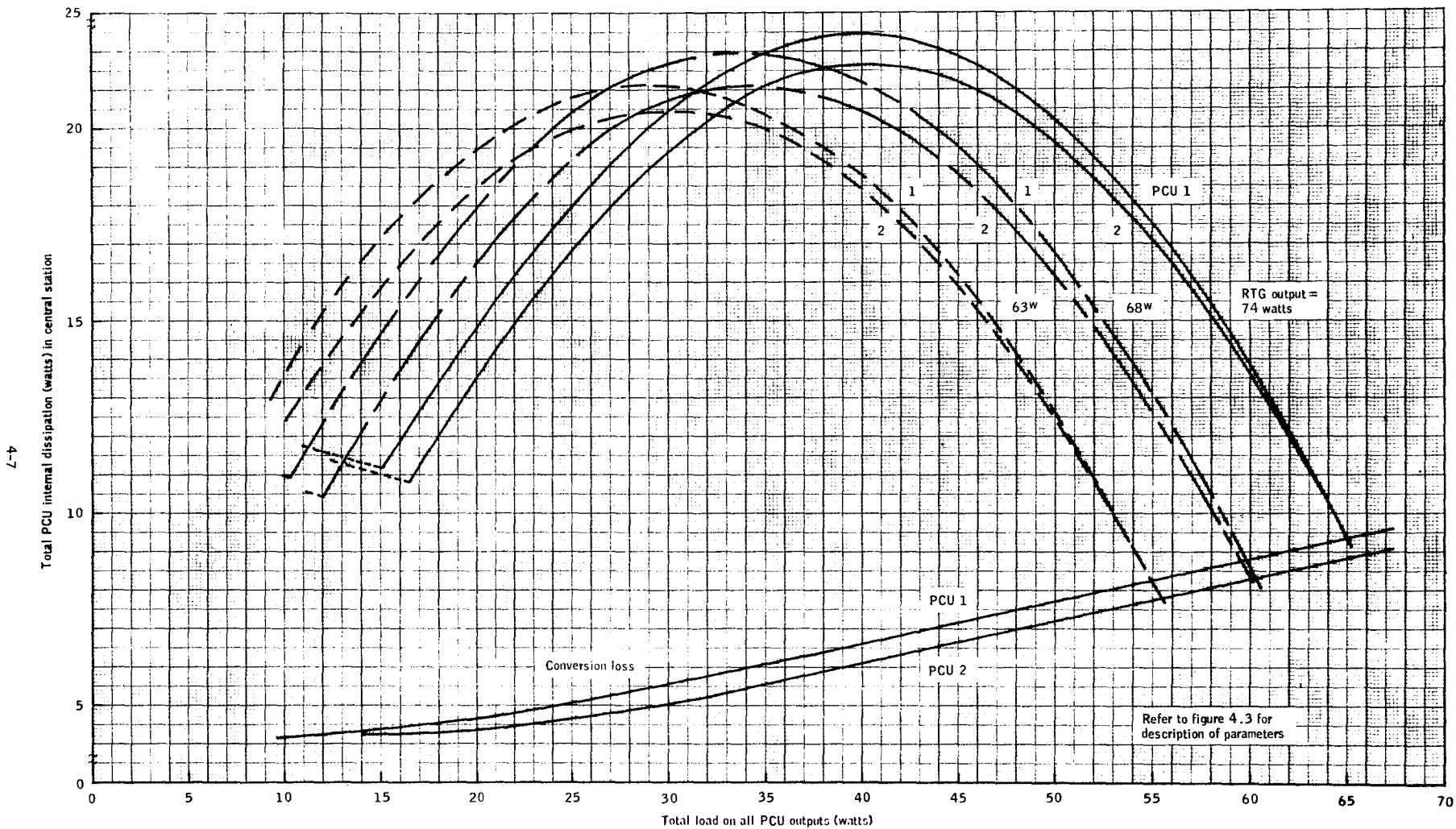

Figure 4-4.- PCU load vs RTG power output vs central station dissipation.

Circuit breaker resetting is provided by internally generating a Standby Select command using the contacts of a current sensing relay. Should an overcurrent condition exist through the sensing coil in series with the experiment operational power line, the contacts of the sensing relay break the Standby Select command line and apply a ground signal to each of two relay drivers. One relay driver operates the power select relay to the Standby Power position. The other driver operates the standby power interruption relay to close the contacts supplying power to the standby power line. Operation of the standby power interruption relay provides power to the reset coil of the overload sensing relay thereby resetting its contacts to permit normal Standby Select command inputs.

Transmitter power control and overload protection uses two power control relays, four overload sensing relays, and associated relay drivers. Four commands are required:

- A. Transmitter On
- B. Transmitter Off
- C. Transmitter A Select
- D. Transmitter B Select.

The Transmitter On and Off commands operate the double pole double throw relay which switches both +12 Vdc and +29 Vdc to the transmitter transfer relay. When the transmitter is off, +29 Vdc is switched to the 8.4-watt transmitter heater. If either Transmitter A or Transmitter B power line is overloaded, the contacts of the overload sensing relay transfers the transmitter select relay to supply power to the alternate transmitter. When power is transferred to the alternate transmitter, the circuit overload sensing relays are both reset and the normal command link inputs are restored. Diplexer switching power, required only when Transmitter B is selected, is obtained directly from the +12 Vdc Transmitter B power line.

The command receiver requires both +12 Vdc and -6 Vdc for operation. The -6 Vdc line is not provided with circuit protection. The +12 Vdc line is provided with overload protection which uses a magnetic latching circuit breaker relay. The circuit breaker will in turn actuate relay K-19 and therefore interrupt +12 Vdc. Since no redundancy of receivers exists, a 12-hour reset pulse is supplied to the breaker every 12 hours. If the receiver is tripped off, +12 Vdc is switched to the 1.25-watt receiver heater.

For data processor power control, redundant electronics are switched using standard magnetic latching relays. These relays are controlled by ground commands. Overload protection is not provided.

Power dissipation Resistor 1, power dissipation Resistor 2, and the central station DSS Heater 3 are switched off and on by ground command only.

Electronics for the dust detector consist of the following three functional areas which are illustrated in Drawing 7.1.

- A. Power switching
- B. Operational amplifiers
- C. Temperature measurement

The power switching function switches +12 Vdc and -12 Vdc power to the amplifiers upon receiving a ground command. The switching function consists of a command flip-flop and power switching circuits. Power protection is provided by fuses. Note that power switching does not affect the temperature measurements.

TABLE 4-I.- PCU OVER AND UNDER VOLTAGE

Over and Under Voltage Sensing Circuit - An automatic switchover circuit in PCU 1 operates when the +12 Vdc bus varies outside of the following limits. The sensing circuit causes a switch from PCU 1 to PCU 2 only.

<u>Sensing Circuit</u>	<u>Voltage Level</u>	<u>Time Delay</u>
Over Voltage	+13 \pm 0.25 Vdc	10 ms
Under Voltage	+11 \pm 0.25 Vdc	300 ms

TABLE 4-II.- POWER CALCULATIONS

<u>TM Symbol</u>	<u>Resultant (Watts)</u>
(AE-3) x (AE-4)	= RTG Output Power
(AE-3) x (AE-5)	= Reserve Power PCU 1
(AE-3) x (AE-6)	= Reserve Power PCU 2
(RTG Output Power) - (Reserve Power)	= PCU Input Power
(AE-3) (AE-5) - (AE-5) ² (4.2Ω)	= Internal Reg #1 Dissipation
(AE-3) (AE-6) - (AE-6) ² (4.2Ω)	= Internal Reg #2 Dissipation

TABLE 4-III.- PDU RELAY INITIAL CONDITIONS

Initial condition is defined as the relay positions at time of activation of the lunar surface.

<u>RELAY</u>	<u>FUNCTION</u>	<u>MONITOR</u>	<u>INITIAL CONDITION</u>
K-01	PCU Select	AE-5	PCU 1 Selected
K-02, K-03	D/P Select	None	D/P X Selected
K-04	XMTR Off, XMTR Htr On	No Downlink	XMTR Off
K-05	XMTR A, XMTR B Select	AE-17	XMTR A Selected
K-06, K-07	Exp #1 Power Control	AB-4	Exp #1 in Stby
K-08, K-09	Exp #2 Power Control	AB-4	Exp #2 in Stby (Note)
K-10, K-11	Exp #3 Power Control	AB-5	Exp #3 in Stby
K-12, K-13	Exp #4 Power Control	AB-5	Exp #4 in Stby
K-14, K-15	DSS Htrs 1 and 2	AB-5	Off
K-16	PDR #1 On/Off	AE-5	Off
K-17	PDR #2 On/Off	AE-5	Off
K-18	DSS Heater 3 On/Off	AE-5	10-watt DSS Htr 3 On
K-19	Receiver Protection	Command Capability	Receiver On

NOTE

Exp #2 (LSM) has no standby heater.

TABLE 4-IV.- CIRCUIT BREAKER AND FUSE TABULATION

<u>SYMBOL NUMBER</u>	<u>RATING</u>	<u>SUBSYSTEM</u>	<u>CIRCUIT</u>	<u>EFFECT</u>
CB-01	110 to 225 mA	Command Receiver	+12 Vdc	Receiver overload causes breaker CB-01 to switch in 1.25-watt receiver heater. No protection for heater. Breaker reset by 12-hour timer.
CB-02	110 to 225 mA	Transmitter A	+12 Vdc	Transmitter A +12 Vdc overload causes breaker CB-02 to switch Transmitter B on. Breaker CB-02 is self-resetting.
CB-03	560 to 840 mA	Transmitter A	+29 Vdc	Transmitter A +29 Vdc overload causes breaker CB-03 to switch Transmitter B on. Breaker CB-03 is self-resetting.
CB-04	110 to 225 mA	Transmitter B	+12 Vdc	Transmitter B +12 Vdc overload causes breaker CB-04 to switch Transmitter A on. Breaker CB-04 is self-resetting.
CB-05	560 to 840 mA	Transmitter B	+29 Vdc	Transmitter B +29 Vdc overload causes breaker CB-05 to switch Transmitter A on. Breaker CB-05 is self-resetting.
CB-06	450 to 550 mA	PSE Operate	+29 Vdc	PSE instrument overload causes breaker CB-06 to place PSE in standby. Breaker CB-06 is self-resetting.
CB-07	450 to 550 mA	LSM Operate	+29 Vdc	LSM instrument overload causes breaker CB-07 to place LSM to off. <u>NOTE:</u> LSM has no standby heater. Breaker CB-07 is self-resetting.
CB-08	450 to 550 mA	SWS Operate	+29 Vdc	SWS instrument overload causes breaker CB-08 to place SWS in standby. Breaker CB-08 is self-resetting.
CB-09	450 to 550 mA	SIDE/CCGE Operate	+29 Vdc	SIDE/CCGE instrument overload causes breaker CB-09 to place SIDE/CCGE in standby. Breaker CB-09 is self-resetting.
CB-10	450 to 550 mA	Thermal	+29 Vdc	Overload on 10-watt heater line (DSS Htr 1) causes CB-10 to switch in 5-watt heater (DSS Htr 2). CB-10 is self-resetting.
F-01	250 mA	Dust Detector	-12 Vdc	A blown fuse F-01 will permanently disable the dust detector resulting in loss of photoelectric cell voltage TM parameters AX-4, AX-5, and AX-6.
F-02	250 mA	Dust Detector	+12 Vdc	A blown fuse F-02 will permanently disable the dust detector, resulting in loss of photoelectric cell voltage TM parameters AX-4, AX-5, and AX-6 and photoelectric cell temp TM parameters AX-1, AX-2, and AX-3.
F-03	500 mA	PSE Standby	+29 Vdc	A blown F-03 will permanently disable the PSE standby capability.
F-04	500 mA	LSM Standby	+29 Vdc	A blown F-04 will only affect TM parameters AB-4. Refer to Drawing 4.2.
F-05	500 mA	SWS Standby	+29 Vdc	A blown F-05 will permanently disable the SWS standby capability.
F-06	500 mA	SIDE/CCGE Standby	+29 Vdc	A blown F-06 will permanently disable the SIDE/CCGE standby capability.
F-07	500 mA	Thermal	+29 Vdc	A blown F-07 will permanently disable DSS Htr 2.

TABLE 4-v.- VOLTAGE DISTRIBUTION AND BUS LOAD ANALYSIS

NOTE

Experiment operational power is defined as maximum nighttime steady state (e.g. PSE Oper). Experiment standby power is defined as maximum heater power (e.g. PSE Stby). The voltage distribution and load analysis represent measurements at an ambient temperature of 70°F.

<u>VOLTAGE BUS</u>	<u>CIRCUIT</u>	<u>WATTS</u>	<u>mAdc</u>	<u>CIRCUIT PROTECTION (Drawing 4.2)</u>
+29 Vdc (+0.40, -0.41)	PSE Oper	7.8	270	CB-06 500 mA ±10%
	Stby	4.5	155	F-03 500 mA
	LSM Oper	10.5	360	CB-07 500 mA ±10%
	Stby (No Htr)	0.0	0	F-04 500 mA
	SWS Oper	6.5	225	CB-08 500 mA ±10%
	Stby	4.0	138	F-05 500 mA
	SIDE Oper	10.5	360	CB-09 500 mA ±10%
	Stby	6.0	206	F-06 500 mA
	DSS Htr 1	10.0	345	CB-10 500 mA ±10%
	DSS Htr 2	5.0	172	F-07 500 mA
	XMTR A	6.0* - 9.0**	207-308	CB-03 560 to 840 mA
	XMTR B	6.0* - 9.0**	207-308	CB-05 560 to 840 mA
	XMTR Htr	8.4	290	None
	DSS Htr 3	10.0	345	None
	PDR 1	7.0	240	None
	PDR 2	14.0	485	None
	PDU	0.375	13	None
+15 Vdc (+0.30, -0.20)	DSS/A	.065	4.34	None
	PDU	.075	5.0	None
+12 Vdc (+0.10, -0.15)	CMD DEC	.325	27.1	None
	Diplexer Sw	.150	12.5	CB-04 110 to 225 mA
	DSS/A	.150	12.5	None
	DSS/D	.05	4.17	None
	Dust Det	.380	31.6	F-02 250 mA
	PCU	Negligible		None
	PDU	.735	61.1	None
	Receiver	.665	55.5	CB-01 110 to 225 mA
	Revr Htr	1.25	104	None
	Temp Sensors	Negligible		None
	XMTR A	.500	41.7	CB-02 110 to 225 mA
XMTR B	.500	41.7	CB-04 110 to 225 mA	
+5 Vdc (+0.25, -0.15)	CMD DEC	.775	155	None
	DSS/A	1.10	220	None
	DSS/D	.450	90	None
	PDU	.085	17	None
	Relay Drivers	Negligible		None
-6 Vdc (+0.15, -0.10)	CMD DEC	.230	38.4	None
	PDU	Negligible		None
	Receiver	.030	5.0	None
-12 Vdc (+0.20, -0.40)	DSS/A	.120	10	None
	Dust Det	.160	13.2	F-01 250 mA
	PDU	.475	39.6	None

* at -10°F
** at +140°F

TABLE 4-VI.- COMMANDS CAUSING A POWER DEMAND

Tabulation of ΔP caused by command execution assuming the following conditions exist:

Transmitter	Off
PDR #1	Off
PDR #2	Off
DSS Heater 3	Off
Dust Detector	Off
PSE	Off
LSM	Off
SWS	Off
SIDE/CCGE	Off
DSS Htr 1 and 2	Off

The ALSEP subsystems will demand electrical power from the PCU in the following amounts:

	<u>Power</u>	<u>mAdc</u>
Transmitter Heater	8.40 Watts	345.0
Receiver	0.70 Watts	60.5
DSS/D	0.50 Watts	94.2
DSS/A	1.44 Watts	247.0
CMD Decoder	1.33 Watts	220.0
PDU	1.75 Watts	137.0
PCU (voltage regulator)	1.5 Watts	(Refer to note)
Distribution Losses	<u>1.5 Watts</u>	
Total	17.12 Watts	

17.12 Watts represents the base for the delta power demands caused by the execution of the following commands:
(Refer to individual experiment power profiles.)

<u>Command</u>	<u>Delta Power</u>	<u>Delta mAdc</u>	<u>Notes</u>
013 Transmitter On	1.0 Watts 1.15 Watts		XMTR A selected by CMD 012. XMTR B selected by CMD 015.
017 PDR #1 On	7.0 Watts	242	
022 PDR #2 On	14.0 Watts	483	
024 DSS Heater 3 On	10.0 Watts	345	Thermostatically controlled.
027 Dust Detector On	0.3 Watts	25	
036 Exp #1 Oper Sel (PSE)	5.07 Watts 7.84 Watts	174 270	Day scientific mode. Above +125°F Night scientific mode. Below +125°F (2.77 Watt difference due to heater. See CMD 076)
	12.7 Watts	440	Turn on transient.
037 Exp #1 Stby Sel (PSE)	4.5 Watts	155	Survival heaters.
042 Exp #2 Oper Sel (LSM)	5.5 Watts 10.5 Watts	190 360	Day scientific mode. Above +35°C. Night scientific mode. Below +35°C. (5 Watt difference due to heaters. See CMD 134).
	10.2 Watts	354	Turn on transient.
045 Exp #3 Oper Sel (SWS)	6.2 Watts 6.5 Watts	214 225	Day scientific mode. Night scientific mode. (0.3 Watts difference due to heaters).
	11.8 Watts	408	Turn on transient
046 Exp #3 Stby Sel (SWS)	4.0 Watts	138	Survival heaters.
052 Exp #4 Oper Sel (SIDE/CCGE)	6.5 Watts 10.5 Watts	224 360	Day scientific mode. Night scientific mode. (4.0 Watts difference due to thermostatically controlled heater).
	11.5 Watts	397	Turn on transient
053 Exp #4 Stby Sel (SIDE/CCGE)	6.0 Watts 2.0 Watts	207 69	Survival heater (Night). Below 0°C. Survival heater (Day). Above 0°C.
055 DSS Htr 1 Sel	10.0 Watts	345	Commandable heater.
056 DSS Htr 2 Sel	5.0 Watts	172	Commandable heater.
070 Level Power "X" Motor (PSE)	3.6 Watts	124	Above PSE operate power (see CMD 036). Exp #1 (PSE) must be operational.

TABLE 4-VI.- COMMANDS CAUSING Δ POWER DEMAND - Concluded

<u>Command</u>	<u>Delta Power</u>	<u>Delta mAdc</u>	<u>Notes</u>
071 Level Power "Y" Motor (PSE)			Same as CMD 070.
072 Level Power "Z" Motor (PSE)			Same as CMD 070.
076 Thermal Control Mode (PSE)			
Auto	0.2 to 2.77 Watts	6.9 to 96	Proportional heater.
Forced	2.77 Watts	96	Heater on continuously.
Off	0.0 Watts	0	Heater off. Exp #1 (PSE) must be operational.
107 and 110 Remove Dust Cover (SIDE)	6.0 Watts	207	Transient for 2.5 seconds. Remove dust cover one time function (day only). Exp #4 (SIDE) must be operational.
122 SWS Dust Cover Removal	5.0 Watts	172	Transient for 4.0 seconds. Dust cover removal one time function (day only). Exp #3 (SWS) must be operational.
131 Flip/Cal Initiate (LSM)	3.4 Watts (day) 1.0 Watts (night)	117 34.5	Exp #2 (LSM) must be operational. Heaters switched off during flip cal sequence. (1.0 Watt above nominal night power demand of 10.9 Watts.)
133 Site survey (LSM)	4.5 Watts	155	Day only. Exp #2 (LSM) must be operational.
134 Temp Control (LSM) X or Y	5.0 Watts	103	Thermostatically controlled heaters.
Off	0.0 Watts	0	Heaters off. Exp #2 (LSM) must be operational.

NOTE

Less than 1.5 watts reserve power will turn
Exp #4 to standby. PCU conversion loss (4
watts dissipation at minimum PCU loading)
or shunt regulator dissipation not included.
Conversion loss and shunt regulator dissi-
pation variable depending on PCU loading.
Refer to Figure 4-4.

TABLE 4-VII.- CENTRAL STATION STILBY STATE POWER DEMANDS ON EACH VOLTAGE BUS FROM THE PCU

SUBSYSTEM	+29 Vdc	+15 Vdc	+12 Vdc	-12 Vdc	-6 Vdc	+5 Vdc	TOTAL	NOTES
XMTR A	6.0 Watts* 9.0 Watts*		0.5 Watts 41.7 mA				Watts 6.5 (-10°F) 9.5 (+140°F)	CMD 012 selects A XMTR. XMTR A protection: +12 Vdc CB-02, +29 Vdc CB-03 CMD 015 selects E XMTR. XMTR B protection: +12 Vdc CB-04, +29 Vdc CB-05.
XMTR B	6.0 Watts* 9.0 Watts*		0.65 Watts 54 mA				6.65 Watts 9.65 Watts	CMD 013 turns on selected XMTR. CMD 014 turns off selected XMTR.
XMTR HTR	8.4 Watts 290 mA						8.4 Watts	Overload on + 12 Vdc bus (110 to 225 mA) or +29 Vdc bus (560 to 840 mA) causes a switch to other transmitter. When XMTR is commanded off (CMD 014) transmitter heater is automatically turned on. The +12 Vdc switched to XMTR B also energizes the diplexer switch.
RECEIVER			0.665 Watts 55.5 mA		0.03 Watts 5.0 mA		0.695 Watts	No ground commands to control receiver. Overload on +12 Vdc bus (110 to 225 mA) disconnects +12 Vdc (via CB-01) from receiver and switches in receiver heater. Receiver is turned back on by 12-hour pulse from timer. -6 Vdc on continuously.
RECEIVER HEATER			1.25 Watts 104 mA				1.25 Watts	
X OR Y DATA PROCESSOR			0.05 Watts 4.2 mA			0.45 Watts 90 mA	0.50 Watts	CMD 034 turns on "X" processor, "Y" processor off. CMD 035 turns on "Y" processor, "X" processor off.
ANALOG MUX		0.065 Watts 4.4 mA	0.15 Watts 12.5 mA	0.12 Watts 10 mA		1.1 Watts 220 mA	1.435 Watts	No overload protection for processors. Either "X" or "Y" processor on. No overload protection for analog multiplexer. Analog MUX on continuously.
COMMAND DECODER			0.325 Watts 27.1 mA		0.230 Watt 38.4 mA	0.775 Watt 155 mA	1.33 Watts	Command decoder is on continuously with no overload protection. Redundant decoders "A" and "B" addressable from ground.
PDU	0.375 Watt 12.9 mA	0.075 Watts 5.0 mA	0.735 Watts 61.1 mA	0.475 Watts 39.5 mA	0.008 Watt 1.3 mA	0.085 Watt 17 mA	1.753 Watts	PDU controls distribution of power to the ALSEP subsystems. +12 Vdc, -12 Vdc, and +5 Vdc are for power sequencer logic. +29 Vdc and +5 Vdc are used for relay drivers located in PDU.
DUST DET			0.38 Watts 31.6 mA	0.16 Watts 13.2 mA			0.54 Watts	CMD 027 turns dust detector on. +12 Vdc bus fuse F01 - -12 Vdc bus fuse F02. 250 mA each. CMD 031 turns dust detector off. Dust detector photo-electrical cell temps on continuously.
PCU 1 OR PCU 2			1.5 Watts				1.5 Watts	CMD 060 turns on PCU-1, PCU-2 off. CMD 062 turns on PCU-2, PCU-1 off. +12 Vdc required for level sensing circuit and regulator amplifiers. Reserve power <1.5 watts, Exp 4 will go to standby.
PDR #1	7.0 Watts 240 mA						7.0 Watts	CMD 017 turns on PDR #1. CMD 021 turns off PDR #1. PDR #1 is located on the CS and is exposed to the Lunar environment.
PDR #2	14.0 Watts 485 mA						14.0 Watts	CMD 022 turns on PDR #2. CMD 023 turns off PDR #2. PDR #2 is located on the CS and is exposed to the Lunar environment.
DSS HEATER 3	10.0 Watts 345 mA						10.0 Watts	CMD 024 turns DSS HTR 3 on. CMD 025 turns DSS HTR 3 off. When on, heaters are thermostatically controlled by ST-01 (Closed - 10°F, Open 0°F). The four heaters are located on the CS thermal plate.
DSS HEATER 2	5 Watts 173 mA						5 Watts	CMD 056 turns DSS Htr 2 on. Protected by R-07 (500 mA). CMD 057 turns DSS Htr 2 off.
DSS HEATER 1	10 Watts 345 mA						10 Watts	CMD 055 turns DSS Htr 1 on. Protected by CB-10 (500 mA ±10%). CMD 056 followed by CMD 057 turns DSS Htr 1 and 2 off.

* Transmitter power demand varies with temperature.



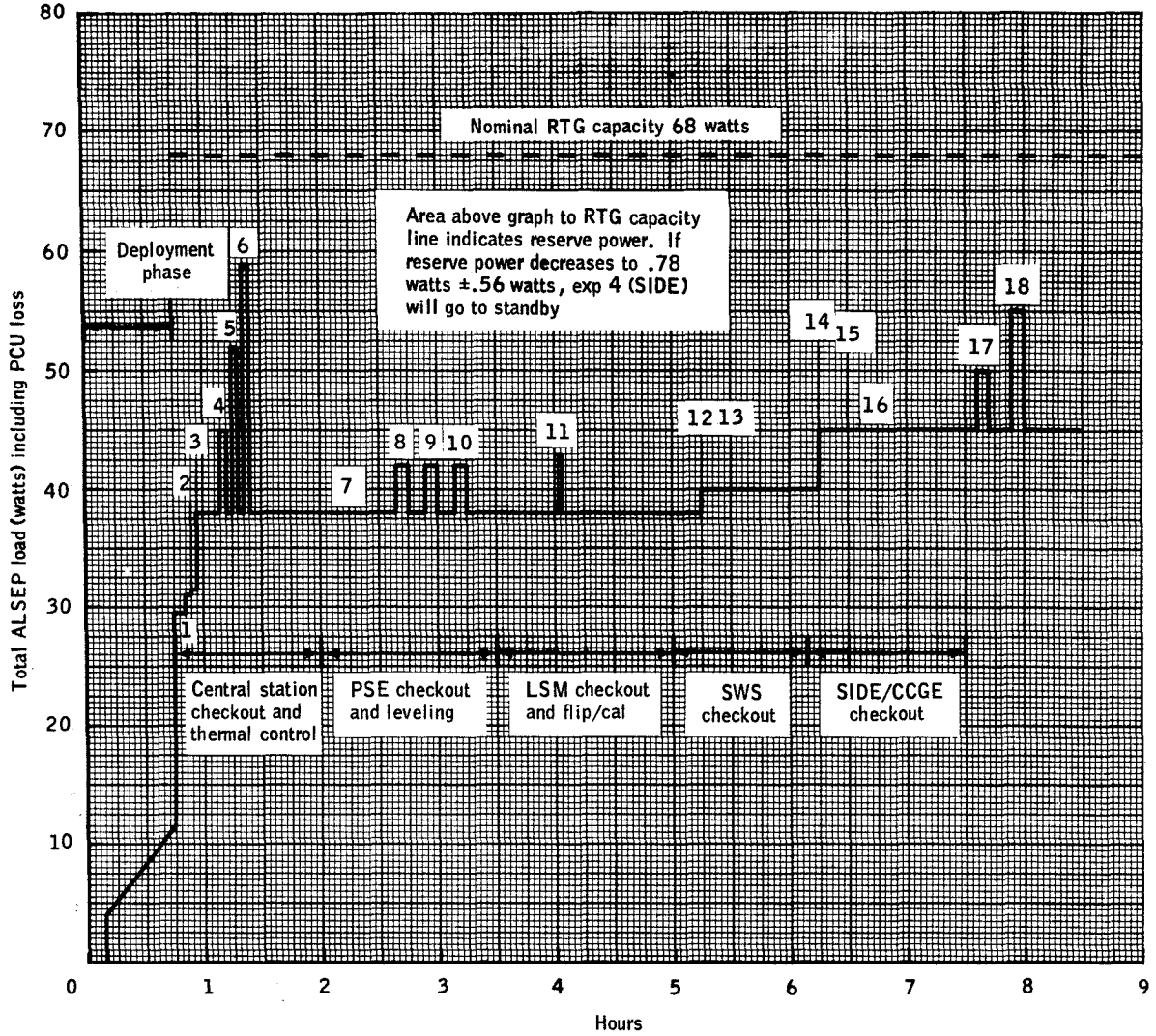

Assume 20° sun angle at zero time (lunar surface temp 100° F)
 no experiment htr power when operational. Times and
 event sequences are approximate. Events ground
 commanded. DSS htr 3 off above 0° F

Events

- | | | |
|----------------------------------|---|----------------------------------|
| 1 XMTR A on | 10 PSE Z level motor on/off | |
| 2 PSE operational | 11 LSM flip/cal (total of four required before site survey) | |
| 3 LSM operational | 12 SWS operational | |
| 4 PDR 1 on | 13 SWS dust cover removal | } May be delayed for soak period |
| 5 PDR 2 on | 14 Side operational | |
| 6 PDR 1 and 2 on | 15 Side dust cover removal | } May be delayed for soak period |
| 7 PSE uncage (no power required) | 16 CCGE seal break (no power required) | |
| 8 PSE X level motor on/off | 17 DSS htr 2 on (for reference only) | |
| 9 PSE Y level motor on/off | 18 DSS htr 1 on (for reference only) | |

Figure 4-6.- Lunar day power profile.

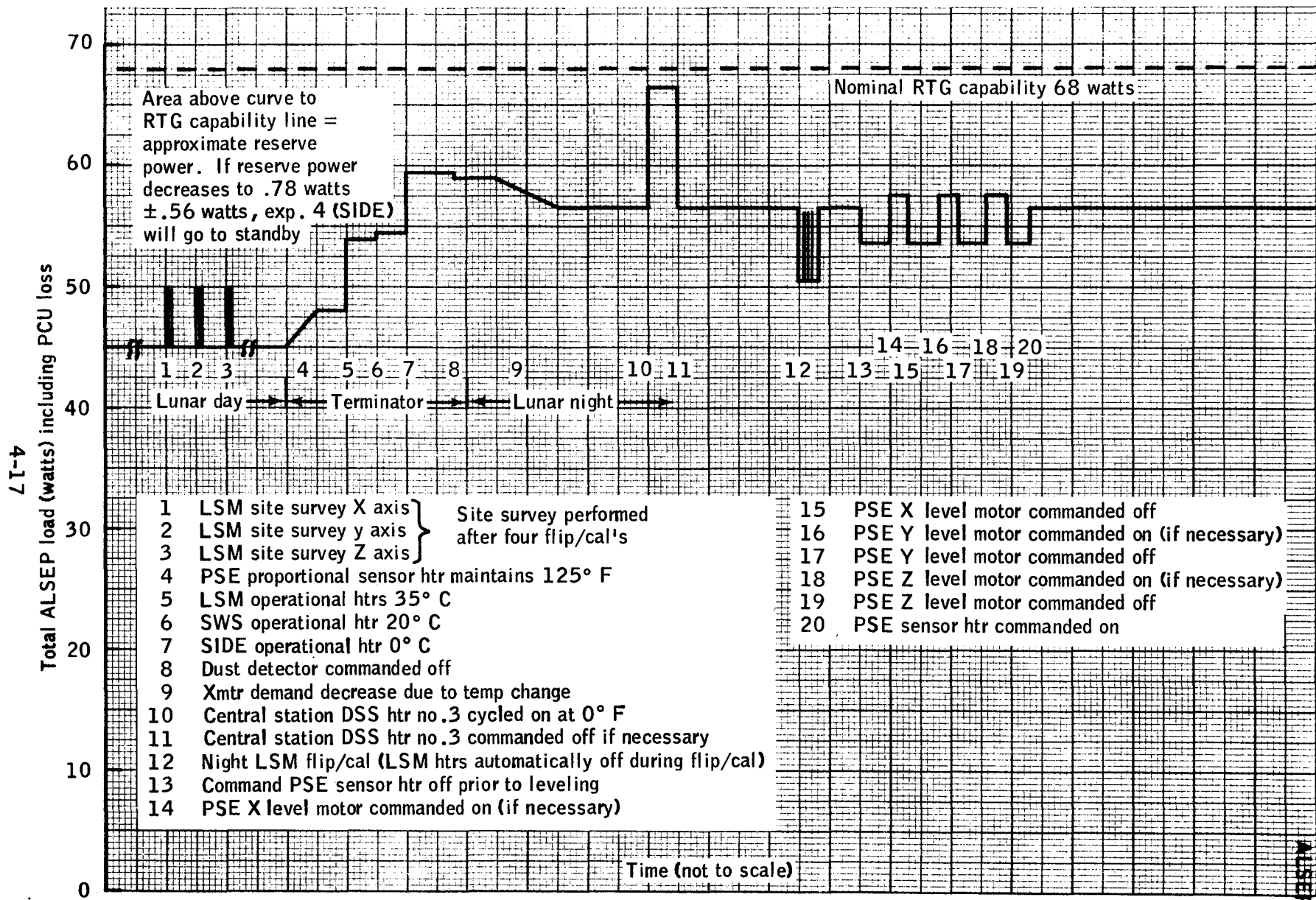

Figure 4-7.- Lunar day to night power profile.

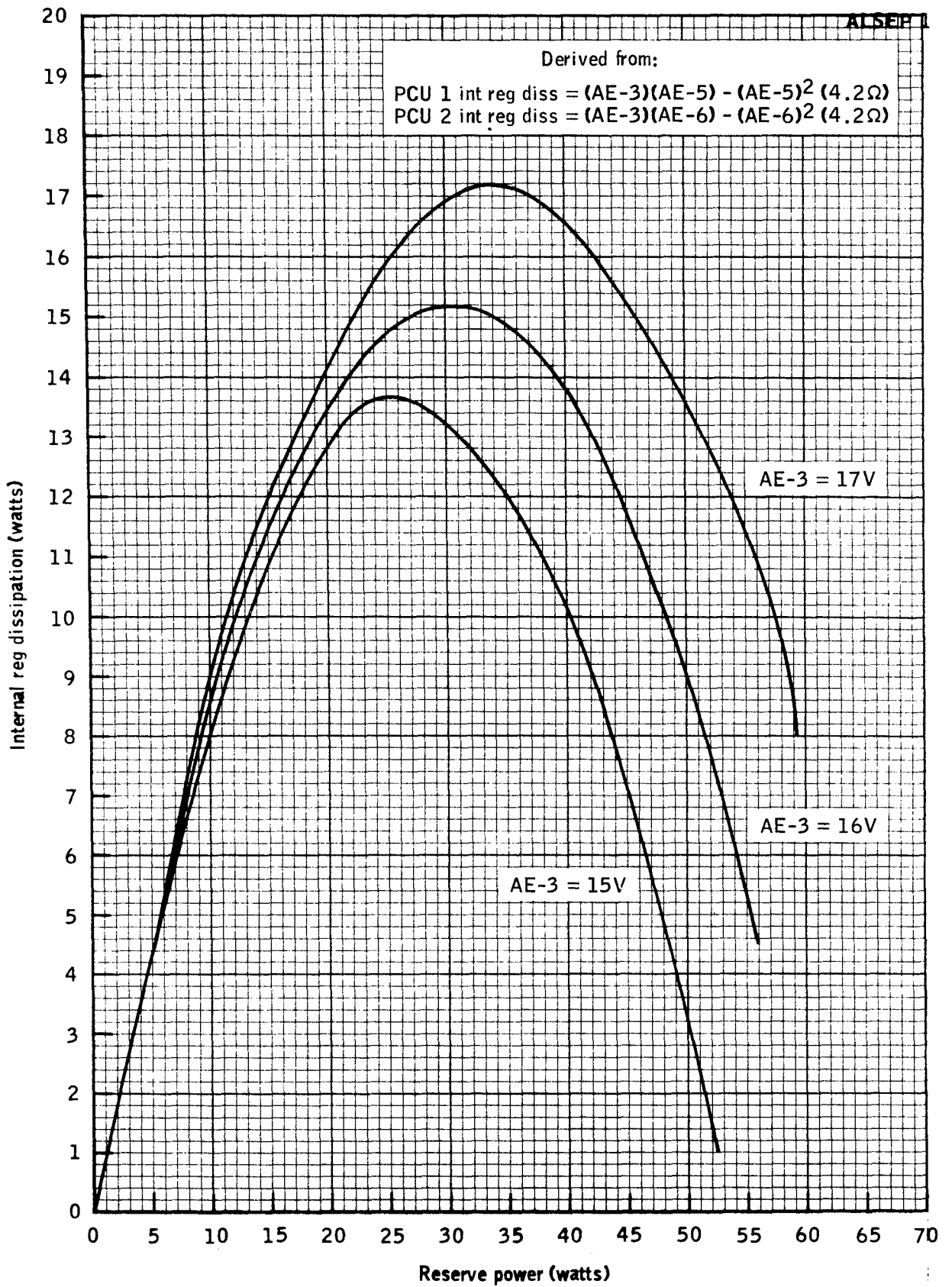

Figure 4-8.- Internal regulator dissipation.

5 COMMAND
SUBSYSTEM

SECTION 5
COMMAND SUBSYSTEM

ALSEP 1

5.1 SYSTEM DESCRIPTION

The ALSEP Command Subsystem receives real-time commands, decodes the commands, and supplies the commands to applicable users to control prescribed operations.

The delayed command sequencer will generate fixed commands, at predetermined times, under the control of the central station timer, to insure that critical enabling and calibration functions are implemented in the event of failure of the uplink.

The following units make up the ALSEP Command Subsystem:

- A. S-band Antenna
- B. Diplexer Filter
- C. Command Receiver
- D. Command Decoder

5.1.1 S-band Antenna

The ALSEP antenna is a modified axial helix designed to receive and to transmit right-hand circular polarized signals at the Apollo S-band frequency.

The antenna has no command requirements, TM measurements, or power requirements.

TABLE 5-I.- ANTENNA OPERATING PARAMETERS

	Antenna Gain	Frequency	Beamwidth	Polarization
Transmit	15.2 db	S-band	27°	Right-Hand
Receive	14.7 db	S-band	27°	Right-Hand

5.1.2 Diplexer Filter

The diplexer is used to couple the received RF from the antenna to the command receiver, and couple the RF signal from the ALSEP transmitter to the antenna.

The diplexer filter has no command requirements, TM measurements, or power requirements.

5.1.3 Command Receiver

- A. The command receiver is a narrow-band FM type, incorporating an FM discriminator for carrier phase modulation detection.

TABLE 5-II.- RECEIVER CHARACTERISTICS

1. Frequency	2119 MHz ± .001%
2. Dynamic Range	-101 to -61 dbm
3. IF Bandwidth	275 kHz @ 3 db
4. Power	695 mW
5. TM Parameters	5

- B. The receiver has redundant local oscillators which are controlled by a level sensor and switch module. When the output power of the local oscillator falls below a given threshold, the switching circuit will switch +12 Vdc to the redundant local oscillator. When power is applied to the receiver, the switching circuit will search between the redundant oscillators until one of the oscillators provides the necessary signal level, at which time the searching between local oscillators will be terminated. The search interval is from 200 to 400 ms. The oscillator in use can be determined by AT 21 (Rcvr XTAL A Deg F) or AT 22 (Rcvr XTAL B Deg F).
- C. Receiver Local Oscillator Switchover Point - The receiver local oscillator level, TM measurement AE-14, will normally indicate 5.0 dbm. Local oscillator switchover will occur at approximately 1.0 dbm.

TABLE 5-III.- RECEIVER POWER REQUIREMENTS

<u>Voltage Bus</u>	<u>Watts</u>	<u>DCMA</u>	<u>Circuit Protection</u>
+12 Vdc \pm 1%	.665	55.5	CB-01 110 to 225 mA
-6 Vdc \pm 1%	.03	5.0	None

NOTE

Receiver overload causes CB-01 to switch on the 1.25 watt (104 mAdc @ +12 Vdc) RECEIVER HEATER. CB-01 is reset by the 12-hour timer pulse.

5.1.4 Command Decoder

The decoder consists of the following sections:

- A. Demodulator Section
- B. Redundant Digital Decoder Section
- C. Delayed Command Sequencer
- D. Timer

5.1.4.1 Demodulator section.- The demodulator section accepts the composite audio subcarrier from the command receiver. The composite audio subcarrier is the linear sum of the data and sync subcarriers, where the two-kc data subcarrier is modulated by a 1000 bit per second data stream and the sync signal is a one-kc subcarrier.

The one-kc subcarrier is used to phase-lock a voltage controlled oscillator (VCO) in order to assure command bit synchronization during the decoding process. The detection and extraction of the command bits is accomplished by comparing the two-kc subcarrier with a two-kc synchronized signal produced by the VCO, which is phase-locked by the one-kc subcarrier signal.

5.1.4.2 Digital decoder section.-

A. A redundant digital decoders section is provided. The digital decoders are identical but require different decoder addresses. A command can be executed by either decoder by selecting the proper decoder address. The decoder addresses for ALSEP 1 are the following:

1. ALSEP 1 Decoder A 1011000 (Octal 130)
2. ALSEP 1 Decoder B 0011000 (Octal 030)

The system is unique in that it does not use sub-bit encoding.

The ALSEP command structure consists of 21 bits.

1011000	1000100	MSB	0111011	LSB
7 Bits	7 Bits		7 Bits	
Decoder Address	Command Complement		Command	

A bit-by-bit comparison is made between the command complement and the command for error protection. A minimum of 20 bits must precede the command to insure phase-lock, and a minimum of 20 bits follow the command to allow for command execution.

Upon receipt of a command, a command verification word is inserted in Word 46 of the TM downlink. The command verification word consists of 10 bits. Seven bits in the downlink word are the command received and one bit, called the parity bit, indicates that the command and command complement did or did not compare.

<u>DA-7</u>	<u>DA-5</u>	<u>DA-6</u>
00	0111011	1
MSB	7 Bits	LSB
2 Bits	Command Received	1 Bit
Filler Bits		Parity

Parity Bit "1": Command and command complement compared, and command was executed.

Parity Bit "0": Command and command complement did not compare, and command was not executed.

- B. Normal Decoder Operation - The redundant Decoders A and B receive the command data, timing pulses, and the threshold signal simultaneously. The threshold signal is used to indicate to the decoders that phase-lock has been achieved.

Decoders A and B will search through the command data until one decoder receives a valid address, at which time the other decoder is inhibited. The decoder that received the valid address starts its programer at the count of 29. At a count of 36, the command complement is contained in the decoder shift register. At this time, a bit-by-bit comparison is made against the incoming command. At a programer count of 43, the command is contained in the shift register. If a compare was made, the command is executed for 20 ms, until the programer count is 63. Non-comparison will prevent execution of the command. The command can be downlinked as a command verification word (CVW) only after the count of 63 through 2047.

The seven bits of command information and the one bit that indicates compare or no compare are held in the shift register until a Data Demand Signal from the data processor at Word 46 time is inputted, at which time the 8 bits are shipped serially to the digital processor to be inserted into Word 46 of the PCM downlink. The end of the Data Demand Signal generates a Data End Reset which returns the decoders to the search mode.

C. Command Decoder Reset Capability

1. Power Reset - A separate power reset circuit is provided for Decoder A and B. The purpose of this is to assure that both decoders will start in the search mode when power is applied to ALSEP. The reset circuits will also reset the decoders to the search mode in case of a momentary drop of approximately 3 Vdc on the 5 Vdc Bus. The power reset circuit in Decoder A will reset the timer inhibit circuit in the timer pulse shaping section and allow the command decoder to accept the 12-hour and the one-minute pulses from the timer. If a power reset signal is received during the decoding process of a command, the decoding process will be terminated at that time, and the decoders will return to the search mode. If a power reset is received after the decoding process is complete, the command will be executed, but a CVW will not be received.
2. Demand Override Reset - In the event that the decoders did not receive a Data End Reset signal, the decoder programer will generate a reset signal 1984 ms (programer count 2047) after command execution.
3. Threshold Loss Reset - Loss of phase-lock between the one-kc sync signal that is uplinked and the one-kc signal derived from the eight-kc VCO during the decoding process of the command, will generate a threshold loss reset signal. The decoding process will terminate at this time and the decoders will return to the search mode. If the decoding process has been completed, the command will be executed and a command verification will be received.

- 5.1.4.3 Delayed command sequencer. - Provisions have been incorporated to automatically generate eight commands to provide a backup feature in the event of an uplink failure.

The delayed command sequencer receives 12-hour timing pulses and 1-minute timing pulses from the timer which advance the "hours" and "minutes" counters (see Drawing 5.1). A power reset will cause the counters to be reset to zero.

Through various combinations of "and" gates connected to these counters, the delayed command sequencer will output the following commands at the times stated. The timer becomes active at PET-zero. PET-zero is defined as the time of RTG plug-in to the central station.

The following commands can be initiated by RTC's or by the delayed command sequencer. The CVW will be available only if the command was by RTC.

<u>A. One-Time Commands</u>	<u>Normal Time of Execution after PET-zero</u>
1. Set CCIG seal break (CMD 105) and arm PSE* uncage circuit (CMD 073)	96 hours + 2 minutes
2. Execute CCIG seal break (CMD 110)	96 hours + 3 minutes
3. Remove SWS dust cover (CMD 122) and set SIDE remove dust cover (CMD 107)	96 hours + 4 minutes
4. Execute SIDE remove dust cover (CMD 110)	96 hours + 5 minutes

<u>B. Repetitive Commands</u>	<u>Normal Time of Execution after PET-zero</u>
1. Magnetometer flip calibrate (CMD 131)	108 hours + 1 minute and every 12 hours thereafter.
2. Restore power to lowest priority experiment (SIDE) (CMD 052)	108 hours + 7 minutes and every 12 hours thereafter.

Command Octal 033 inhibits the automatic commands generated by the delayed command sequencer and 12-hour timer.

The 12-hour timer commands are listed below for reference and are not generated by the delayed command sequencer.

<u>C. Repetitive Commands (every 12 hours after PET-zero)</u>
1. Command receiver reset
2. Short period calibrate PSE (same as CMD 065)
3. Uncage PSE*
a. Arm uncage PSE (at PET-zero +12 hours)
b. Execute uncage PSE (at PET-zero +24 hours)

5.1.4.4 Timer.- The timer is an electro-mechanical device which produces three separate switching functions: repetitive 1-minute, repetitive 12-hour, and a non-repetitive 2-year closure. The 1-minute and 12-hour switch closures are used as inputs to the delayed command sequencer. The 12-hour timer function can be observed on AL-7 (PSE CAL STA) and DL-8 (PSE SP DATA). The 2-year switch closure is used to permanently terminate ALSEP transmitter operation. A power reset (Paragraph 5.1.4.2.C.1) will not affect the 2-year switch closure.

The timer mechanism is driven independently of any ALSEP power by means of a zinc-mercuric-oxide cell. Jumper wires in the RTG plug cause the timer to start when the RTG is connected to the central station. This time is defined at package elapsed time (PET) minus zero, and the time is accumulative.

TABLE 5-IV.- CENTRAL STATION TIMER CHARACTERISTICS

1-minute output	<u>+200 ms</u>
12-hour output	<u>+10 min</u>
2-year output	<u>+30 days</u>
Timer starts at PET-zero.	

TABLE 5-V.- COMMAND DECODER POWER REQUIREMENTS

<u>Voltage Bus</u>	<u>Watts</u>	<u>mAdc</u>	<u>Protection</u>
+12 Vdc <u>± 1%</u>	.325	27.1	None
+5 Vdc <u>± 1%</u>	.775	155	None
-6 Vdc <u>± 1%</u>	.230	38.4	None

*Uncaging of the PSE will normally be accomplished by two successive ground commands 073. However, as a backup, two successive 12-hour timer pulses or one 12-hour timer pulse and the 96-hour 2-minute one-time command pulse will affect uncaging. Arming the uncaging circuit and then placing the PSE to standby will also affect uncaging.

5.2

COMMAND FUNCTIONS

003 ASE HBR ON DATA PROCESSOR

Command 003 disconnects the data processor from the modulator and connects the modulator to the Active Seismic processor which supplies the high bit rate data (10,600 bps). The ASE HBR ON command takes effect at the scheduled end of the 64-word data processor frame which is in progress at the time the mode change command is received. The downlink data is meaningless if this command is executed with no ASE in the flight configuration.

005 ASE HBR OFF DATA PROCESSOR

Command 005 disconnects the ASE processor from the modulator and connects the modulator to the data processor which supplies data at 530 or 1060 bps, depending on the last bit rate mode commanded. The ASE HBR OFF command takes effect at the scheduled end of the 64-word data processor frame which is in progress at the time the mode change command is received. Central station activation or power reset initializes ASE HBR to OFF.

006 NORM BIT RT SEL DATA PROCESSOR

Command 006 causes the data processor to operate at the normal bit rate (1060 bps). This command takes effect at the scheduled end of the 64-word frame which is in progress at the time the mode change command is received. Central station activation or power reset initializes the data processor to NORMAL BIT RATE. Switching bit rates will cause sync loss at ground station.

007 LOW BIT RT SEL DATA PROCESSOR

Command 007 causes the data processor to operate at low bit rate (530 bps). This command takes effect at the scheduled end of the 64-word frame which is in progress at the time the mode change command is received. Switching bit rates will cause sync loss at ground station.

NOTE

EXP 2 (LSM) data are meaningless on LOW BIT RATE.

011 NORM BIT RT RST DATA PROCESSOR

Command 011 is a provision for returning the operational data processor (determined by Command 034 or 035) to the normal bit rate from either the high or low bit rate. This command does not reset the analog multiplexer or frame counter. This command takes effect immediately and does not wait until the scheduled end of the 64-word frame.

NOTE

This command may result in sync loss at ground station, hence possible loss or false readout of command verification word.

012 XMTR A SEL POWER DISTRIBUTION UNIT

Command 012 actuates relay K-05, in the PDU, to the position that selects Transmitter A. XMTR A SEL is the lunar surface initial condition. Switching transmitters will cause sync loss at ground station.

013 XMTR ON POWER DISTRIBUTION UNIT

Command 013 actuates relay K-04, in the PDU, which applies +12 Vdc and +29 Vdc to the transmitter selected by Command 012 or 015. This command simultaneously removes +29 Vdc from the 8.4-watt transmitter heater located on the thermal plate.

014 XMTR OFF POWER DISTRIBUTION UNIT

Command 014 actuates relay K-04, in the PDU, to the position that removes +12 Vdc and +29 Vdc from the transmitter selected by Command 012 or 015. This command simultaneously applies +29 Vdc to the 8.4-watt transmitter heater. XMTR OFF is the lunar surface initial condition.

015 XMTR B SEL POWER DISTRIBUTION UNIT

Command 015 actuates relay K-05, in the PDU, to the position that selects Transmitter B. Switching transmitters will cause sync loss at ground station.

017 DISSIP R1 ON POWER DISTRIBUTION UNIT

Command 017 actuates relay K-16, in the PDU, to the position that applies +29 Vdc to a 7-watt power dump resistor and is used to optimize the load on the PCU.

NOTE

SINCE THIS COMMAND INHIBITS THE RECEIVER RESET, IT IS CONSIDERED HIGHLY CRITICAL.

This command will input level changes to the hours and minutes counters of the delayed command sequencer and advance the counters by 12 hours and 1 minute. This may change the execution times of the automatic commands from the delayed command sequencer and the timer.

This command does not inhibit or affect the two-year transmitter turn-off command generated by the timer.

034 DSS/PROC X SEL POWER DISTRIBUTION UNIT

Command 034 actuates relays K02 and K-03, in the PDU, that apply operational voltages (+15 Vdc, +5 Vdc, -12 Vdc) to the "X" data processor. It simultaneously removes the above voltages from the "Y" processor. The "X" data processor, upon activation, is initialized to the normal bit rate. DSS/PROC X SEL is the lunar surface initial condition.

NOTE

This command may result in sync loss at ground station, hence possible loss or false readout of command verification word.

035 DSS/PROC Y SEL POWER DISTRIBUTION UNIT

Command 035 actuates relays K-02 and K-03, in the PDU, that apply operational voltages (+15 Vdc, +5 Vdc, -12 Vdc) to "Y" data processor. It simultaneously removes the above voltages from the "X" processor. The "Y" data processor, upon activation, is initialized to the normal bit rate.

NOTE

This command may result in sync loss at ground station, hence possible loss or false readout of command verification word.

036 EXP 1 OPER SEL (PSE) POWER DISTRIBUTION UNIT

Command 036 actuates relay K-06, in the PDU, applying +29 Vdc to the PSE instrument and the heater circuitry in the deployed PSE sensor assembly. It simultaneously removes +29 Vdc from the standby heater in the PSE electronics package in the central station.

037 EXP 1 STBY SEL (PSE) POWER DISTRIBUTION UNIT

Command 037 actuates relays K-06 and K-07, in the PDU, applying +29 Vdc to the standby heater in the PSE electronics package and to the heater in the deployed PSE sensor assembly. It simultaneously deactivates the PSE by removing +29 Vdc from the instrument. EXP 1 STBY SEL (PSE) is the lunar surface initial condition.

041 EXP 1 STBY OFF (PSE) POWER DISTRIBUTION UNIT

Command 041 actuates relay K-07, in the PDU, to the position that removes +29 Vdc from both PSE heater circuits. If the PSE operating power is on, transmission of this command will have no effect.

042 EXP 2 OPER SEL (LSM) POWER DISTRIBUTION UNIT

Command 042 actuates relay K-08, in the PDU, applying +29 Vdc to activate the LSM.

043 EXP 2 STBY SEL (LSM) POWER DISTRIBUTION UNIT

Command 043 actuates relays K-08 and K-09, in the PDU, to the position that deactivates the LSM instrument but does not apply standby power. EXP 2 STBY SEL (LSM) is the lunar surface initial condition.

- 044 EXP 2 STBY OFF (LSM) POWER DISTRIBUTION UNIT
 Command 044 actuates relay K-09, in the PDU, to the position that removes +29 Vdc from the resistive summing network to TM parameter AB-4. The LSM uses no standby power. If the LSM operating power is on, transmission of this command will have no effect.
- 045 EXP 3 OPER SEL (SWS) POWER DISTRIBUTION UNIT
 Command 045 actuates relay K-10, in the PDU, applying +29 Vdc to activate the SWS instrument. This command simultaneously deactivates the SWS standby heater.
- 046 EXP 3 STBY SEL (SWS) POWER DISTRIBUTION UNIT
 Command 046 actuates relays K-10 and K-11, in the PDU, applying +29 Vdc to the SWS standby heater. This command simultaneously deactivates the SWS instrument. EXP 3 STBY SEL (SWS) is the lunar surface initial condition.
- 050 EXP 3 STBY OFF (SWS) POWER DISTRIBUTION UNIT
 Command 050 actuates relay K-11, in the PDU, to the position that removes +29 Vdc from the SWS standby heater. If the SWS operating power is on, transmission of this command will have no effect.
- 052 EXP 4 OPER SEL (SIDE) POWER DISTRIBUTION UNIT
 Command 052 actuates relay K-12, in the PDU, applying +29 Vdc to the SIDE instrument and the SIDE heater. This command is also generated by the delayed command sequencer (see Command 033).
- 053 EXP 4 STBY SEL (SIDE) POWER DISTRIBUTION UNIT
 Command 053 actuates relays K-12 and K-13, in the PDU, applying +29 Vdc to the SIDE heater. It simultaneously deactivates the SIDE by removing +29 Vdc from the instrument. EXP 4 STBY SEL (SIDE) is the lunar surface initial condition.
- 054 EXP 4 STBY OFF (SIDE) POWER DISTRIBUTION UNIT
 Command 054 actuates relay K-13, in the PDU, to the position that removes +29 Vdc from the SIDE heater. If the SIDE operating power is on, transmission of this command will have no effect.
- 055 DSS HTR 1 SEL POWER DISTRIBUTION UNIT
 Command 055 actuates relay K-14, in the PDU, to the position that applies +29 Vdc to the 10-watt DSS HTR 1.
- 056 DSS HTR 2 SEL POWER DISTRIBUTION UNIT
 Command 056 actuates relays K-14 and K-15, in the PDU, to the position that applies +29 Vdc to the 5-watt DSS HTR 2 and simultaneously removes +29 Vdc from DSS HTR 1.
- 057 DSS HTR 2 OFF
 Command 057 actuates relay K-15, in the PDU, to the position that removes +29 Vdc from the 5-watt DSS HTR 2. If DSS HTR 1 is ON, this command will have no effect. Initially, DSS HTR 1 and 2 will be OFF.
- 060 PCU 1 SEL POWER CONDITIONING UNIT
 Command 060 actuates relay K-01, in the PCU, which applies +16 Vdc from the RTG to PCU 1 and simultaneously de-energizes PCU 2. PCU 1 is preset to be energized at initial lunar activation. Note that there is an automatic switchover feature to PCU 2 in the event the +12 Vdc bus varies more than ±1 Vdc. Adding or removing electrical loads (via ground commands) on PCU 1 can prevent the +12 Vdc bus from varying out of limits.

NOTE

IN THE EVENT AUTOMATIC SWITCHOVER TO PCU 2 HAS OCCURRED, THIS COMMAND MUST BE FLAGGED AS HIGHLY CRITICAL. THE CAUSE OF THE SWITCHOVER MUST BE DETERMINED BEFORE THIS COMMAND IS EXECUTED.

SWITCHOVER FROM PCU 1 TO PCU 2 MAY GENERATE A POWER RESET SIGNAL TO THE DELAYED COMMAND SEQUENCER COUNTERS, RESETTING THE COUNTERS BACK TO ZERO. PCU SWITCHING WILL CAUSE SYNC LOSS AT GROUND STATION.

- 062 PCU 2 SEL POWER CONDITIONING UNIT
 Command 062 actuates relay K-01, in the PCU, which applies +16 Vdc from the RTG to PCU 2 and simultaneously de-energizes PCU 1.

NOTE

AT THE TIME OF LUNAR ACTIVATION PCU 2 IS DE-ENERGIZED, WITH NO MEANS TO DETERMINE ITS CONDITION. FURTHER, NOTE THAT THERE IS NO AUTOMATIC SWITCHOVER FROM PCU 2 TO PCU 1. THIS SITUATION, THEREFORE, MAKES THIS COMMAND HIGHLY CRITICAL. THIS COMMAND SHOULD BE EXECUTED ONLY AFTER DETERMINING THAT PCU 1 IS ON THE VERGE OF FAILING.

SWITCHOVER FROM PCU 2 to PCU 1 MAY GENERATE A POWER RESET SIGNAL TO THE DELAYED COMMAND SEQUENCER COUNTERS, RESETTING THE COUNTERS BACK TO ZERO. PCU SWITCHING WILL CAUSE SYNC LOSS AT GROUND STATION.

063 PSE/XY GAIN CH EXP 1 (PSE)

Command 063 switches different attenuator values into the LPX and LPY amplifier circuits to allow gain control of the long period X- and Y-axis signals. Repeated transmission of the command will cause the attenuators to step through values of 0 db, -10 db, -20 db, and -30 db in a repeating sequence. In addition, this command controls the calibration current of these two axes. PSE activation initializes the attenuators to -30 db.

064 PSE/Z GAIN CH EXP 1 (PSE)

Command 064 switches different attenuator values into the LPZ amplifier circuit to allow gain control of the long period Z-axis signal. Repeated transmission of the command will cause the attenuator to step through values of 0 db, -10 db, -20 db, and -30 db in a repeating sequence. In addition, this command controls the calibration current of this axis. PSE activation initializes the attenuator to -30 db.

065 PSE/SP CAL CH EXP 1 (PSE)

Command 065 activates logic that will apply a current, via the SP calibration attenuator, to the SP calibration coil. The amount of current from the calibration attenuator is determined by Command 067. In addition, the SP calibration is automatically performed every 12 hours by means of the timer unless specifically inhibited by Command 033. This is a sequential ON/OFF command. PSE activation initializes SP calibration to OFF.

066 PSE/LP CAL CH EXP 1 (PSE)

Command 066 activates logic that applies current, via the LP calibration attenuators, to the LP damping coils (all three axes simultaneously). The amount of current from the calibration attenuators is determined by Command 063 and Command 064. This is a sequential ON/OFF command. PSE activation initializes LP calibration to OFF.

067 PSE/SP GAIN CH EXP 1 (PSE)

Command 067 switches different attenuator values into the SPZ amplifier circuit to allow gain control of the SP axis signal. Repeated transmission of the command will cause the attenuator to step through values of 0 db, -10 db, -20 db, and -30 db in a repeating sequence. In addition, this command controls the calibration current of this axis. PSE activation initializes the attenuator to -30 db.

070 LVL MTRX ON/OFF EXP 1 (PSE)

Command 070 activates logic which applies power to the X-axis drive motor. This is a sequential ON/OFF command. PSE activation initializes X motor to OFF. Note that the X motor consumes power in either leveling mode (AUTOMATIC/FORCED) until commanded OFF.

NOTE

Do not turn on more than one leveling motor at a time.
De-energize sensor heater via Command 076 during time any level motor is on.

071 LVL MTRY ON/OFF EXP 1 (PSE)

Command 071 activates logic which applies power to the Y-axis drive motor. This is a sequential ON/OFF command. PSE activation initializes Y motor to OFF. Note that the Y motor consumes power in either leveling mode (AUTOMATIC/FORCED) until commanded OFF.

NOTE

Do not turn on more than one leveling motor at a time. De-energize sensor heater via Command 076 during time any level motor is on.

072 LVL MTRZ ON/OFF EXP 1 (PSE)

Command 072 activates logic which applies power to the Z-axis drive motor. This is a sequential ON/OFF command. PSE activation initializes Z motor to OFF. Note that the Z motor consumes power in either leveling mode (AUTOMATIC/FORCED) until commanded OFF.

NOTE

DO NOT TURN ON Z LEVELING MOTOR WHILE PSE IS CAGED. Do not turn on more than one leveling motor at a time. De-energize sensor heater via command 076 during time any level motor is on.

073 UNCAGE ARM/FIRE EXP 1 (PSE)

- A. Command 073 is a two-state command (ARM/FIRE). First transmission will arm the actuator circuit. Second transmission of this command is sent to fire the actuator circuit and uncage all spring mass systems simultaneously. This command is an irreversible function and is necessary to obtain PSE scientific data.
- B. The ARM and FIRE commands are also automatically generated by the timer every 12 and 24 hours, respectively, after PET-zero.
- C. Conditions to ARM:
 1. First transmission of Command 073.
 2. First 12-hour timer pulse.
 3. 96 hours + 2 minutes pulse from the delayed command sequencer.
- D. Conditions to FIRE (after ARM, above):
 1. Next transmission of Command 073.
 2. Next 12-hour timer pulse.
 3. If armed, placing PSE to standby (Command 037 or operational overload).

NOTE

THE UNCAGE CIRCUITRY WILL NOT FUNCTION BELOW 30°F.

074 LVL DIR POS/NEG EXP 1 (PSE)

Command 074 is a two-state command (POS/NEG) which controls the direction of the level motors for LPX, LPY, and LPZ axes when in the forced leveling mode (see Command 103). PSE activation initializes leveling direction to POS.

075 LVL SPEED HI/LO EXP 1 (PSE)

Command 075 is a two-state command (HI/LO) which controls the speed of the leveling motors for LPX, LPY, and LPZ axes when in the forced leveling mode (see Command 103). PSE activation initializes leveling speed to LO.

076 PSE T CTL CH EXP 1 (PSE)

Command 076 is a four-state command that can be sequentially stepped through the following modes to control the heater in the deployed PSE sensor.

- A. OFF - +29 Vdc is disconnected from the heater.
 - B. FORCED - +29 Vdc applied to heater and automatic thermostat control disabled.
 - C. OFF - +29 Vdc is disconnected from the heater.
 - D. AUTOMATIC - +29 Vdc applied to heater and automatic thermostat control enabled.
- PSE activation initializes thermal control mode to AUTOMATIC.

Note that this command does not control the heater in the PSE electronics package in the central station.

Note that the PSE sensor heater is not controlled by this command when the experiment is in EXP 1 STBY SEL.

101 PSE FILT IN/OUT EXP 1 (PSE)

Command 101 is a two-state command (IN/OUT) which effectively removes the feedback loop filters from the LPX, LPY, and LPZ axes. PSE activation initializes the feedback filter to OUT.

The feedback filter has to be in the following modes for the PSE to operate properly:

- A. Leveling (all modes) - filter OUT
- B. Calibration - filter IN
- C. Normal operational mode - filter IN

102 LVL SNSR IN/OUT EXP 1 (PSE)

Command 102 is a two-state command (IN/OUT) which activates logic that enables the coarse level sensors to control the LPX and LPY axes drive motors when an off level condition exists. The coarse level sensors are used only in the automatic leveling mode. PSE activation initializes the coarse level sensor to OUT.

103 PSE LVL MDE A/F EXP 1 (PSE)

Command 103 is a two-state command (AUTOMATIC/FORCED) which controls the leveling mode of LPX, LPY, and LPZ axes. PSE activation initializes the leveling mode to AUTOMATIC.

NOTE

Only one axis motor is to be on at a time.

SIDE/CCGE COMMANDS EXP 4 (SIDE/CCGE)

The following commands are encoded by the SIDE into two one-time commands and fifteen operational commands:

- 104 SIDE LOAD 1
- 105 SIDE LOAD 2
- 106 SIDE LOAD 3
- 107 SIDE LOAD 4*
- 110 SIDE EXECUTE*

Encoding is as follows:

FUNCTION	SIDE COMMAND REGISTER ENCODING				
	104	105	106	107	110
One Time Commands {	BREAK CCIG SEAL	X			X
	REMOVE DUST COVER			X	X
1. GND PLANE STEP PROGRAMER ON/OFF	X				X
2. RESET SIDE FRAME COUNTER AT 10		X			X
3. RESET SIDE FRAME COUNTER AT 39	X	X			X
4. RESET VELOCITY FILTER AT 9			X		X
5. RESET SIDE FRAME COUNTER AT 79	X		X		X
6. RESET SIDE FRAME COUNTER AT 79 AND VELOCITY FILTER AT 9		X	X		X
7. X10 ACCUMULATION INTERVAL ON/OFF	X	X	X		X
8. MASTER RESET				X	X
9. VELOCITY FILTER VOLTAGE ON/OFF	X			X	X
10. LECPA HIVOLTAGE ON/OFF		X		X	X
11. HECPA HIVOLTAGE ON/OFF	X	X		X	X
12. FORCE CONTINUOUS CALIBRATION (RESET TO 120)			X	X	X
13. CCIG HIVOLTAGE ON/OFF	X		X	X	X
14. CHANNELTRON HIVOLTAGE ON/OFF		X	X	X	X
15. RESET COMMAND REGISTER	X	X	X	X	X

* Refer to Note 1, Figure 11-1.

NOTE

Commands to break CCIG seal and reset SIDE frame counter at 10 are identical. The first transmission of Commands 105 and 110 causes both functions to occur but not thereafter. Commands to remove dust cover and master reset are also identical. The first transmission of Commands 107 and 110 causes both functions to occur but not thereafter.

A brief description of SIDE commands follows:

The SIDE/CCIG commands are functionally divided into two types, on/off commands and mode commands. Initiation of a mode command changes the operational data format characteristics.

Operationally executing any mode or on/off command will eliminate the existing operational mode. Operationally executing any of the following on/off commands 1, 7, 9, 10, 11, 13 and 14 will reset the SIDE frame counter (DI-1) to zero if any one of the mode commands 2, 3, 4, 5, 6 or 12 is present in the mode register, whereas execution of mode commands will not affect the status of any on/off commanded functions.

One-time commands:

BREAK CCIG SEAL

Command 105 followed by 110 causes the one-time function of CCIG seal break. It simultaneously resets the SIDE FRAME COUNTER at 10 (described later). This command is an irreversible function and is necessary to obtain CCGE scientific data. This command is also generated by the delayed command sequencer (see Command 033).

REMOVE DUST COVER

Command 107 followed by 110 causes the one-time function of blowing the SIDE dust cover. It simultaneously resets the SIDE MASTER RESET (described later). This command is an irreversible function and is necessary to obtain SIDE scientific data. This command is also generated by the delayed command sequencer (see Command 033). REMOVE DUST COVER command may cause a heater interrupt. (Refer to Fig. 11-1.)

ON/OFF Commands and Mode Commands:

1. GROUND PLANE STEP PROGRAMER ON/OFF EXP 4 (SIDE/CCGE)

Command 104 followed by 110 is a two-state command (ON/OFF) that controls the operation of the ground plane step programer. SIDE activation initializes the programer to ON. The ground plane voltage is then stepped through 24 levels (one level/SIDE cycle). Transmission of this command will cause the step programer to stop. Retransmission will start step programer and does not reset voltage level to zero but continues to step from level where last stopped.

2. RESET SIDE FRAME COUNTER AT 10 EXP 4 (SIDE/CCGE)

Command 105 followed by 110 is a mode command. (Initiation of a mode command changes the operational data format characteristics.) Upon receipt of the command, the experiment resets to SIDE frame zero and then steps to SIDE frame 10 before resetting again to zero. The velocity filter and the high and low energy curved plate analyzers step through the values obtained for these SIDE frames in the NORMAL MODE of operation. The ground plane voltage steps through the normal 24 step sequence, one step per 11 frame cycle. (See Figure 11-3.)

3. RESET SIDE FRAME COUNTER AT 39 EXP 4 (SIDE/CCGE)

Commands 104 and 105, followed by 110, is a mode command. Upon receipt of the command, the experiment operates in a similar fashion to the reset at 10 mode except that it resets at SIDE frame 39.

4. RESET VELOCITY FILTER COUNTER AT 9 EXP 4 (SIDE/CCGE)

Command 106 followed by 110 is a mode command. The experiment, in this mode, executes the normal 128 SIDE frame cycle. The velocity filter voltage only executes the first 10 of its normal 20 step program. That is, at SIDE frame 10, instead of completing the 20 steps, the velocity filter assumes the value of SIDE frame 20 in the normal mode. Similarly at SIDE frame 20, the filter adopts the normal mode value of SIDE frame 40. This operation continues for the complete 128 SIDE frames. The low energy curved plate analyzer, instead of maintaining its value for 20 SIDE frames, steps to the next value every 10 SIDE frames. This means that the six values are repeated from SIDE frame 60. (See Figure 11-5.)

5. RESET SIDE FRAME COUNTER AT 79 EXP 4 (SIDE/CCGE)
 Commands 104 and 106, followed by 110, is a mode command. Upon receipt of the command, the experiment operates in a similar fashion to the reset at 10 mode except that it resets at SIDE frame 79.
6. RESET SIDE FRAME COUNTER AT 79 AND VELOCITY FILTER COUNTER AT 9 EXP 4 (SIDE/CCGE)
 Commands 105 and 106, followed by 110, is a mode command. Upon receipt of the command, the experiment performs the functions of command RESET VELOCITY FILTER COUNTER AT 9, but the sequence stops at SIDE frame 79 and repeats.

All other functions are unchanged from the normal operational mode.

- 7. X10 ACCUMULATION INTERVAL ON/OFF EXP 4 (SIDE/CCGE)
 Commands 104, 105, and 106, followed by 110, is a two-state command (ON/OFF). The accumulation time period is increased from a normal 1.2 seconds (X1) to 12 seconds (X10). Each SIDE frame is downlinked 10 times before advancing to the next SIDE frame. The X10 mode can be used with any counter reset mode.
8. MASTER RESET EXP 4 (SIDE/CCGE)
 Command 107 followed by 110 is a mode command. Upon receipt of the command, the experiment will return to the normal operational mode.

 The master reset shall perform the following:
 - a. Defeat all short cycles.
 - b. Reset SIDE frame counter, velocity counter, HECPA and LECPA counters.
 - c. Does not disturb any ON/OFF commands or X10 accumulation interval.
- 9. VELOCITY FILTER VOLTAGE ON/OFF EXP 4 (SIDE/CCGE)
 Commands 104 and 107, followed by 110, is a two-state command (ON/OFF). Transmission of this command removes velocity filter voltage (i.e., filter voltage equals zero Vdc). However, the velocity filter programmer is not inhibited, and upon retransmission of this command, the velocity filter assumes the appropriate voltage level of that SIDE frame in process.
- 10. LOW ENERGY CPA HIGH VOLTAGE ON/OFF EXP 4 (SIDE/CCGE)
 Commands 105 and 107, followed by 110, is a two-state command (ON/OFF). Transmission of this command removes LECPA voltage (i.e., LECPA equals zero Vdc). However, the LECPA programmer is not inhibited, and upon retransmission of this command, the LECPA assumes the appropriate voltage level of that SIDE frame in process. With zero voltage, no low-energy data is transmitted.
- 11. HIGH-ENERGY CPA HIGH VOLTAGE ON/OFF EXP 4 (SIDE/CCGE)
 Commands 104, 105, and 107, followed by 110, is a two-state command (ON/OFF). Transmission of this command removes HECPA voltage (i.e., HECPA equals zero Vdc). However, the HECPA programmer is not inhibited, and upon retransmission of this command, the HECPA assumes the appropriate voltage level of that SIDE frame in process. With zero voltage, no high-energy data is transmitted.
12. FORCE CONTINUOUS CALIBRATION (RESET TO 120) EXP 4 (SIDE/CCGE)
 Commands 106 and 107, followed by 110, is a mode command. Upon receipt of the command, the experiment resets to SIDE frame 120 and then steps through SIDE frame 127 before resetting again to SIDE frame 120.
- 13. COLD CATHODE ION GAGE HIGH VOLTAGE ON/OFF EXP 4 (SIDE/CCGE)
 Commands 104, 106, and 107, followed by 110, is a two-state command (ON/OFF). Transmission of this command turns off high voltage to the CCIG sensor, thereby disabling all CCGE scientific data.
- 14. CHANNELTRON HIGH VOLTAGE ON/OFF EXP 4 (SIDE/CCGE)
 Commands 105, 106, and 107, followed by 110, is a two-state command (ON/OFF). Transmission of this command removes high voltage from the channeltron multipliers, thus disabling SIDE scientific data.
15. RESET COMMAND REGISTER EXP 4 (SIDE/CCGE)
 Commands 104, 105, 106, and 107, followed by 110, are commands used to clear the command register of any command awaiting execution.

Note SIDE power ON will cause the following:

- a. A power reset will force the instrument into the normal mode, which is the following:

- (1) Removes all short cycles.
- (2) Resets SIDE frame counter, velocity counter, HECPA and LECPA counter.
- (3) Resets ground plane counter
- b. Resets all Command Flip-Flops.
- c. Turns on all the internal voltages of the system (turns on V/FILT, HECPA, LECPA, Channeltron HV, CCIG HV).

122 SWS CVR GO EXP 3 (SWS)

Command 122 causes the one-time function of removing the SWS dust covers. This command is an irreversible function and is necessary to obtain SWS scientific data.

122 SWS CVR GO (Three times \leq 10 seconds) EXP 3 (SWS)

Command 122, when sent three times within 10 seconds, places the high voltage amplifiers in the high gain mode. SWS activation presets the amplifiers to be low gain mode. The low gain mode of operation causes the 21 voltage steps applied to the Faraday cup sensors during proton and electron measurements to be scaled such that the highest level will be 6 kilovolts. The high gain mode increases the gain of the amplifiers by a factor of 1.68, with the highest level going to 10 kilovolts. STBY SEL command (046) followed by an OPER SEL command (045) presets the amplifiers to the low gain mode.

123 LSM RANGE STEPS EXP 2 (LSM)

Command 123 is a three-state command that determines the range of the X-, Y-, and Z-axis sensors of the LSM. LSM activation initializes the range to ± 400 gamma. Repeated application of this command sequences the range through ± 100 , ± 200 , ± 400 gamma. The selected range is common to all three sensors.

124 LSM FLD O/S CH EXP 2 (LSM)

Command 124 is a seven-state command that controls field offset of the X-, Y-, and Z-axes. LSM activation initializes the offset to zero percent. Repeated application of this command sequences the offset through +25, +50, +75, -75, -50, -25, and zero percent of the range selected by Command 123. Example: With Command 123 set to ± 100 gamma and Command 124 set to +25 percent, the effective range of the addressed sensor would be ± 125 to -75 gamma (sensor heads in 0° or 90° position).

125 LSM O/S ADD CH EXP 2 (LSM)

Command 125 is a four-state command used to address the X-, Y-, and Z-axes for offsetting. LSM activation initializes the offset address to neutral. Neutral is defined as no axis addressed. Repeated application of this command sequences the offset address from X to Y to Z to neutral. Example: With this command set to the X-axis, Command 124 controls the offset of the X-axis only, with Y- and Z-axes unaffected.

127 FLIP/CAL INHIB EXP 2 (LSM)

Command 127 is a two-state command (IN/OUT) used to inhibit the flip/calibrate sequence of the LSM. LSM activation initializes the logic to inhibit IN.

NOTE

SINCE THIS COMMAND WILL INHIBIT THE FLIP/CAL COMMAND FROM THE AUTOMATIC DELAYED COMMAND SEQUENCER (SEE COMMAND 033), AND GROUND COMMAND 131, THIS COMMAND MUST BE CONSIDERED CRITICAL BECAUSE OF A POSSIBILITY OF UPLINK FAILURE.

131 FLIP/CAL GO EXP 2 (LSM)

Command 131 is a one-state command that initiates the flip/calibration cycle. Execution of this command activates the flip/cal sequencer, and upon completion of the sequence, the LSM is returned to the normal operating mode and places the sequencer in OFF.

NOTE

THERE MUST BE EXACTLY FOUR FLIP/CALIBRATE CYCLES BEFORE PERFORMING A SITE SURVEY. In addition to ground command 131, the flip/calibrate delayed command sequencer (see Command 033) will generate flip/cal commands.

132 LSM FILT IN/OUT EXP 2 (LSM)

Command 132 is a two-state command (IN/OUT). LSM activation initializes the filter to IN. Application of the command to OUT will cause a major portion of the digital filter to be bypassed.

133 SITE SURVEY XYZ EXP 2 (LSM)

Command 133 is a one-state command that activates the site survey sequence generator. The first application of this command will initiate the sequence to survey the X-axis. Upon completion of the X-axis survey, the LSM instrument will return to the normal scientific mode. The second and third application of this command will initiate the sequence generator to survey the Y- and Z-axes, respectively, returning the LSM to the normal mode of operation upon completion of the respective axis survey.

NOTE

THE SITE SURVEY MUST BE PERFORMED ONLY
AFTER FOUR FLIP/CALIBRATE CYCLES HAVE
BEEN COMPLETED.

134 LSM T CTL XYO EXP 2 (LSM)

Command 134 is a three-state command (X, Y, OFF) which is used to select the X- or Y-axis sensor heater thermostat or to deactivate all LSM heater power. LSM activation initializes the temperature control to the X-axis thermostat. Repeated application of this command sequences the temperature control through Y-axis thermostat, OFF, and X-axis thermostat. The selected axis thermostat (X or Y) controls heater power to all LSM heaters. In the OFF position all LSM heater power is removed. Note that there is no thermostat in the Z-axis sensor.

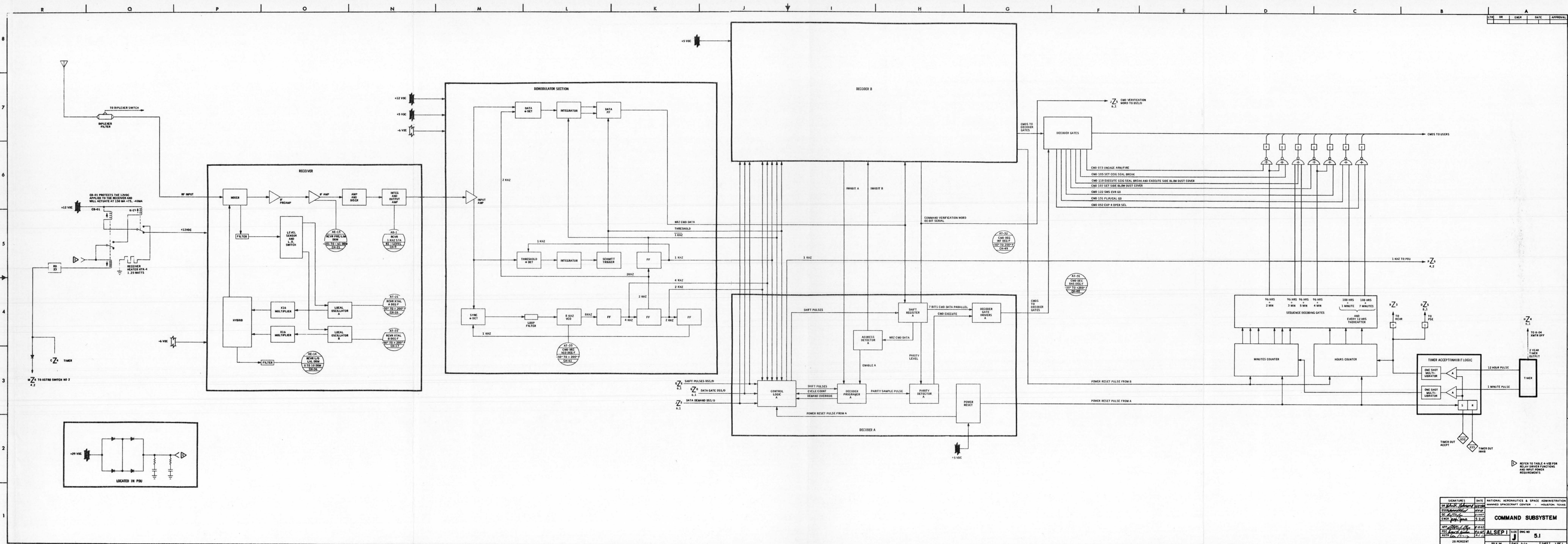

REFER TO TABLE 4-VIS FOR RELAY DRIVER FUNCTIONS AND INPUT POWER REQUIREMENTS

6 TELEMETRY
SUBSYSTEM

SECTION 6

TELEMETRY SUBSYSTEM

6.1 SYSTEM DESCRIPTION

The Telemetry Subsystem consists of central station sensors, experiment sensors, one analog multiplexer, two A/D converters, two digital data processors, two S-band transmitters, one diplexer switch, one diplexer filter, and a common S-band transmit/receive helix antenna.

6.1.1 Sensors (Transducers)

Analog sensors convert such parameters as temperature, voltage, current, and status into 0- to +5-volt signals and input these signals to the 90-channel analog multiplexer as engineering (housekeeping) data to indicate the condition of the central station, RTG, and PSE.

Scientific measurements from the experiment sensors and experiment status, calibration, and temperature data are converted within each experiment to digital data and applied to the X and Y digital data processors at the proper demand time in serial form.

6.1.2 Analog Multiplexer

Analog engineering (housekeeping) data is applied to the 90-channel analog multiplexer. Multiplexer Channels 1 through 15 are redundant. Selection of the redundant channels can be accomplished by ground command, selecting either X or Y data processor (Commands 034 or 035). Channels 16 through 90 are normal channels. The multiplexer is divided into seven groups of 15 column gates each, and the group outputs are further gated through a tier of seven row gates. The channel advance pulse generated in the digital data processor (occurs at the time of the sixty-fourth main frame word) is applied to the analog multiplexer gate sequencers to advance the multiplexer to the next channel after each A/D conversion. The gate sequencers generate a ninetieth-channel output pulse that is used to reset the frame counter located in the digital data processor. The output of the analog multiplexer is buffered by amplifiers at the input to each A/D converter.

6.1.3 A/D Converters

The A/D converters encode the analog signal from the multiplexer into an 8-bit digital word when an encode pulse from the digital data processor occurs (once every digital data processor main frame). The 8-bit digital word is inputted parallel to the digital data processor at Word 33 time of the ALSEP main frame. Selection of A/D converters is accomplished by commands 034 or 035.

6.1.4 Digital Data Processor

Redundant digital data processors (X and Y) are provided. The redundant processors are selectable by Ground Command 034 or 035. The processor that is selected receives data in a parallel form from the A/D converter and in a serial form from the command decoder and experiments. The data is formatted into a serial NRZC format and then encoded into a split-phase signal and applied to the transmitter.

As a backup capability, the data processor provides a low bit rate mode at one-half the normal data rate. The normal or low data rate can be selected by Ground Commands 006 and 007 respectively.

The first three words of the ALSEP main frame are used for the sync code. The bit assignment for the sync word is shown in Figure 6-2. Bits 23 through 29 are provided for channel identification for 1 through 90 channels for correlation of the analog multiplexer data. These bits are derived from a ripple-through counter which is advanced one step whenever Word 1 of the ALSEP main frame occurs and is reset by a ninetieth-frame signal generated by the analog multiplexer. When power is applied to the data processor, these seven bits will be a random count between 0 and 127 and cannot be used to determine the position of the multiplexer until it receives the ninetieth-frame reset signal from the analog multiplexer.

Each of the redundant processors has a power reset circuit. This circuit will reset the processor to the normal mode if there is a momentary drop in the +5 Vdc line.

The data processor will generate and provide all necessary timing signals to the experiments, command decoder, A/D converter, and the 90-channel analog multiplexer (see Table 6-III).

6.1.5 Transmitter

There are two S-band transmitters (A and B) in ALSEP 1, selectable by ground commands. The active transmitter accepts split-phase telemetry data from the data processor, and PM modulates the carrier which is applied to the helix antenna at a one-watt level on a downlink frequency of 2278.5 MHz. Ground Commands are also used to turn the selected transmitter on or off. If the transmitter is commanded OFF, an 8.4-watt heater is simultaneously activated to provide electrical and thermal balance. Overload protection is provided for both transmitters. Circuit breakers associated with the overloaded transmitter will switch operating voltages (+29 Vdc, +12 Vdc) to the other transmitter.

6.1.6 Diplexer Switch

The diplexer switch is utilized to couple the selected transmitter (A or B) output through the diplexer filter to the antenna. The direction of the diplexer switch (thus the selection of transmitter A or B output) is controlled by activating a ferrite device, within the circulator, by a magnetic field from a coil which is energized by +12 Vdc. The +12 Vdc is applied when transmitter B is ON.

TABLE 6-I.- ANALOG MULTIPLEXER A/D CONVERTER CHARACTERISTICS

Analog Multiplexer (Subcommutated)	
Input (From Sensors Or Signal Conditioners)	0 to +5 Vdc
Channels/Frame	90 Max
Seconds/Frame (Normal Bit Rate)	54.34
Seconds/Frame (Low Bit Rate)	108.68
Redundancy	Channels 1 through 15

A/D Converters	
Input (From Analog Mux)	0 to +5 Vdc
Conversion	8 Bits
Data to D/P	Parallel
Time Slot In Main Frame	Word 33
Redundancy	X or Y Converter

Either of the two redundant A/D converters are selectable by Ground Command 034 (DSS/PROC X SEL) or 035 (DSS/PROC Y SEL).

TABLE 6-II.- DIGITAL DATA PROCESSOR CHARACTERISTICS

	<u>Low Bit Rate</u>	<u>Normal Bit Rate</u>
Data Rate (BPS)	530	1060
Bits/Word	10	10
Words/Frame	64	64
Frame/Second	53/64	1-21/32
Seconds/Frame	1.2075	0.6038
Bits/Sync Word	22	22
Redundancy	X or Y Processors	

Words 1, 2, and 3 are control words. Word 33 of the main frame contains housekeeping data from the analog MUX/A/D converter. Word 46 contains the command verification word. The two MSB's of Words 33 and 46 are filler bits inserted by the digital data processor. All main frame words are downlinked MSB first.

DA-4 (Bit 10 of Word 3) contains the Data Processor Serial Number.

Frame 3	0 MSB
Frame 4	1
Frame 5	0

CONTROL GROUP FORMAT

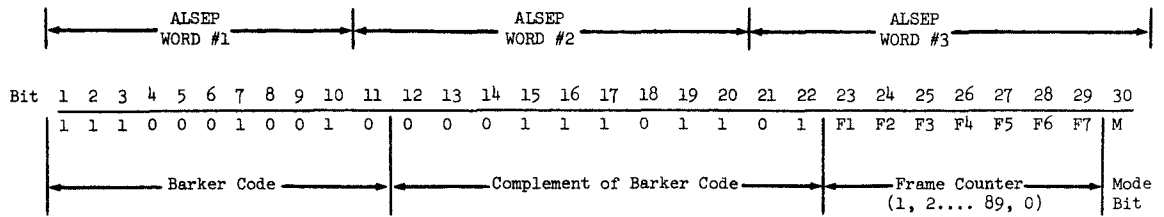

Symbol	Name	ALSEP Words	Range	Bits/ Sample	Samples/ Second
DA-1	Barker Code and Complement	1, 2, and Bits 1 and 2 of Word 3	NA	22	1.67
DA-2	Frame Count	Bits 3 to 9 inclusive of Word 3	0-127 (Frame count reads all zero's on channel 90)	7	1.67
DA-3	Bit Rate ID	Bit 10 of Word 3		1	1.67
		<u>Frame</u> <u>Mode Bit</u>	<u>Meaning</u>		
		1 1	Normal data rate		
		2 1	Low data rate		
DA-4	ALSEP ID	Bit 10, LSB, of Word 3		3	1/54
		<u>Frame</u> <u>Mode Bit</u>			
		3 0 (MSB)	Data processor Serial number ALSEP 1		
		4 1			
		5 0			
DA-5	Received Command Message	Bits 3 to 9 inclusive of Word 46	1 to 127	7	*
DA-6	Command MAP	Bit 10, LSB, of Word 46	"0" no parity "1" parity	1	*
DA-7	Filler Bits	May be used to determine bit error rate during off line processing. Bits 1 and 2 of Word 46.			

*One word sample is sent for each command received; other samples are all zeros.

Figure 6-2.- Control and command verification word format.

TABLE 6-III.- TIMING FROM DIGITAL PROCESSOR

Signals From Data Processor	SIGNAL TO						
	CMD Decoder	PSE	SIDE	LSM	SWS	A/D Converter	Analog MUX
Shift Pulse	X	X	X	X	X		
Data Gate	X	X					
Even Frame Mark		X	X				
Frame Mark				X			
Data Demand	X	X	X	X	X		
A/D Encode						X	
Advance Pulse							X

TABLE 6-IV.- TIMING AND CONTROL PULSE CHARACTERISTICS

Pulse Type	Duration* (μ sec)	Repetition Rate
Frame Mark	118	Once Per ALSEP Frame
Even Frame Mark	118	Once Every Other Frame
90th Frame Mark	118	Once Every 90th Frame
Data Gate (Word Mark)	118	64, Once Per Each Ten- Bit Word in Frame
Data Demand	9434	Once Per Word in ALSEP Frame
Shift Pulse	47	640 Pulses Per Frame 1060 Pulses Per Second, NBR 530 Pulses Per Second, LBR
Command	20,000	Asynchronous

*In slow ALSEP data mode, duration is twice the normal mode.

TABLE 6-V.- TELEMETRY SUBSYSTEM POWER REQUIREMENTS AND OVERLOAD PROTECTION

Component	Voltage Bus	Watts	mA _{dc}	Circuit Protection
Digital Data Processor X or Y	+12 V _{dc} ± 1%	0.05	4.2	None
	+5 V _{dc} ± 1%	0.450	90.0	None
Analog Multiplexer and A/D Converter X or Y	+15 V _{dc} ± 1%	0.065	4.4	None
	+12 V _{dc} ± 1%	0.150	12.5	None
	+5 V _{dc} ± 1%	1.10	220.0	None
Transmitter A or B	-12 V _{dc} ± 1%	0.12	10.0	None
	+29 V _{dc} ± 1%	8.0	275.0	CB-03 XMTR A 560 to 840 mA CB-05 XMTR B 560 to 840 mA
Transmitter Heater	+12 V _{dc} ± 1%	0.5	41.7	CB-02 XMTR A 110-225 mA CB-04 XMTR B 110-225 mA
	+29 V _{dc} ± 1%	8.4	345.0	None
Diplexer Switch	+12 V _{dc} ± 1%	0.15	12.5	CB-04 110-225 mA

TABLE 6-VI.- TRANSMITTER CHARACTERISTICS

Frequency	2278.5 MHz
Modulation	PM
Stability (long-term)	±0.0025 percent/year
Power Output	1 watt minimum
Power Input	6.6-9.45 watts
TM Parameters	4

TABLE 6-VII.- REDUNDANT ANALOG CHANNELS

The first 15 channels of the analog multiplexer are applied in parallel to redundant gates in the analog multiplexer. Either of these redundant gates can be selected by Ground Command 034 (DSS/PROC X SEL) or 035 (DSS/PROC Y SEL).

<u>Channel</u>	<u>Symbol</u>	<u>Location/Name</u>
1	AE-3	Converter Input Voltage
2	AE-1	0.25 Vdc Calibration
3	AE-2	4.75 Vdc Calibration
4	AT-3	Thermal Plate Temp 1
5	AE-4	Converter Input Current
6	AR-1	RTG Hot Frame 1 Temp
7	AR-4	RTG Cold Frame 1 Temp
8	AE-5	Shunt Regulator 1 Current
9	AB-1	Command Demodulator 1 kHz Present
10		Not Assigned
11		Not Assigned
12	AB-4	Power Distribution Exper 1 and 2 Standby
13	AE-6	Shunt Regulator 2 Current
14	AB-5	Power Distribution Exper 3, 4, and DSS Htr 2
15	AT-10	Primary Structure Bottom Temp 1

TABLE 6-VIII.- CHANNEL MEASUREMENT ASSIGNMENTS FOR ANALOG MULTIPLEXER (ALSEP WORD 33)

<u>Channel Number</u>	<u>Symbol</u>	<u>Location/Name</u>	<u>Channel Number</u>	<u>Symbol</u>	<u>Location/Name</u>
1	AE-3	Converter Input Voltage	46	AT-29	Digital D/P, Base Temp
2	AE-1	0.25 Vdc Calibration	47	AT-30	Digital D/P, Internal Temp
3	AE-2	4.75 Vdc Calibration	48	AT-31	Command Decoder Base Temp
4	AT-3	Thermal Plate Temp 1	49	AT-32	Command Decoder Internal Temp
5	AE-4	Converter Input Current	50	AE-9	PCU Output Voltage 3 (12 V)
6	AR-1	RTG Hot Frame 1 Temp	51	AE-15	Transmitter A, AGC Voltage
7	AR-4	RTG Cold Frame 1 Temp	52	AR-3	RTG Hot Frame 3 Temp
8	AE-5	Shunt Regulator 1 Current	53	AL-3	Level Direction and Speed
9	AB-1	Command Demodulator 1 kHz Present	54	AL-7	Calibration and Status LP and SP
10	BLANK		55	BLANK	
11	BLANK		56	AX-3	Dust Cell 3 Temp
12	AB-4	Power Distribution Exper 1 and 2 Standby	57	BLANK	
13	AE-6	Shunt Regulator 2 Current	58	AT-6	Thermal Plate Temp 4
14	AB-5	Power Distribution Exper 3, 4, and DSS Htr 2	59	AT-8	Primary Structure Wall Temp 1 (Left)
15	AT-10	Primary Structure Bottom Temp 1	60	AT-12	Insulation Inner Temp
16	AT-21	Local Oscillator Crystal A Temp	61	AT-33	Command Demodulator, VCO Temp
17	AT-22	Local Oscillator Crystal B Temp	62	AT-34	Power Distribution, Base Temp
18	AT-23	Transmitter A Crystal Temp	63	AT-35	Power Distribution, Internal Temp
19	AT-24	Transmitter A Heat Sink Temp	64	AT-36	PCU, Power Oscillator 1 Temp
20	AE-7	PCU Output Voltage 1 (29 V)	65	AE-10	PCU Output Voltage 4 (5 V)
21	AE-13	Receiver Prelimiting Level	66	AE-16	Transmitter B, AGC Voltage
22	AE-18	Transmitter B Power Doubler dc Current	67	AR-5	RTG Cold Frame 2 Temp
23	AL-1	LP Amplifier Gain (X and Y)	68	AL-4	SP Amplifier Gain (Z)
24	AL-5	Leveling Mode and Coarse Sensor Mode	69	AL-8	Uncage Status
25	BLANK		70	AI-1	LE Count Rate
26	AX-5	Dust Cell 2 Output	71	AT-7	Thermal Plate Temp 5
27	AT-1	Sunshield Temp 1	72	AT-13	Insulation Outer Temp
28	AT-4	Thermal Plate Temp 2	73	BLANK	
29	BLANK		74	BLANK	
30	AX-2	Dust Cell 2 Temp	75	BLANK	
31	AT-25	Transmitter B Crystal Temp	76	AT-37	PCU, Power Oscillator 2 Temp
32	AT-26	Transmitter B Heat Sink Temp	77	AT-38	PCU, Regulator 1 Temp
33	AT-27	Analog DP, Base Temp	78	AT-39	PCU, Regulator 2 Temp
34	AT-28	Analog DP, Internal Temp	79	AE-11	PCU Output Voltage 5 (-12 V)
35	AE-8	PCU Output Voltage 2 (15 V)	80	AE-12	PCU Output Voltage 6 (-6 V)
36	AE-14	Receiver Local Oscillator Level	81	AE-17	Transmitter A Power Doubler dc Current
37	BLANK		82	BLANK	
38	AL-2	LP Amplifier Gain (Z)	83	AX-1	Dust Cell 1 Temp
39	AL-6	Thermal Control Status	84	AX-4	Dust Cell 1 Output
40	BLANK		85	AI-2	HE Count Rate
41	AX-6	Dust Cell 3 Output	86	BLANK	
42	AT-2	Sunshield Temp 2	87	AT-9	Primary Structure Wall Temp 2 (Right)
43	AT-5	Thermal Plate Temp 3	88	AT-11	Primary Structure Wall Temp 3 (Back)
44	BLANK		89	BLANK	
45	BLANK		90	BLANK	

TABLE 6-IX.- EXPERIMENT OFF DOWNLINK STATUS

The observed conditions with Experiment operating power OFF and Experiment standby power either OFF or ON, are as follows:

PSE All "1"s in the digital data words

LSM All "1"s in the digital data words

SIDE All "0"s in the digital data words

SWS All "1"s in the digital data words

Central Station Housekeeping

PSE Channels (AL-1 - AL-8), either 000 or 001

SIDE Channels (AI-1 and AI-2), either 000 or 001

With the experiments disconnected from the central station, all "1"s are present in the digital data words. Open circuit channels to the analog multiplexer can read anywhere between 000 and 255.

TABLE 6-X.- ALSEP 1 ANALOG CHANNEL USAGE

Symbol	Location/Name	Nominal Operating Limits		Nom Oper Value	Redline Limits	
		Low	High		Low	High
<u>Structural/Thermal Temperatures (Fahrenheit)</u>						
AT-1	Sunshield Temp 1	-240°	95°	-80°	-300°	+300°
AT-2	Sunshield Temp 2	-240°	95°	-80°	-300°	+300°
AT-3	Thermal Plate Temp 1	0°	140°	83°	-25°	+150°
AT-4	Thermal Plate Temp 2	0°	125°	83°	-25°	+150°
AT-5	Thermal Plate Temp 3	0°	125°	83°	-25°	+150°
AT-6	Thermal Plate Temp 4	0°	125°	83°	-25°	+150°
AT-7	Thermal Plate Temp 5	0°	125°	83°	-25°	+150°
AT-8	Primary Structure Wall Temp 1 (Left)	-210°	236°	0°	-300°	+300°
AT-9	Primary Structure Wall Temp 2 (Right)	-210°	236°	0°	-300°	+300°
AT-10	Primary Structure Bottom Temp 1	-210°	258°	6°	-300°	+300°
AT-11	Primary Structure Wall Temp 3 (Back)	-50°	250°	28°	-300°	+300°
AT-12	Insulation Inner Temp	-20°	157°	64°	-25°	+167°
AT-13	Insulation Outer Temp	-135°	210°	26°	-300°	+300°
<u>Electronic Temperatures (Fahrenheit)</u>						
AT-21	Local Oscillator Crystal A Temp	-10°	165°	144°	-15°	+170°
AT-22	Local Oscillator Crystal B Temp	0°	125°	75°	-15°	+170°
AT-23	Transmitter A Crystal Temp	-10°	+146°	75°	-15°	+165°
AT-24	Transmitter A Heat Sink Temp	-10°	+146°	75°	-15°	+165°
AT-25	Transmitter B Crystal Temp	-10°	+146°	75°	-15°	+165°
AT-26	Transmitter B Heat Sink Temp	-10°	+146°	75°	-15°	+165°
AT-27	Analog D/P, Base Temp	0°	125°	83°	-25°	+150°
AT-28	Analog D/P, Internal Temp	0°	125°	90°	-15°	+163°
AT-29	Digital D/P, Base Temp	0°	125°	83°	-25°	+150°
AT-30	Digital D/P, Internal Temp	0°	125°	87°	-20°	+158°
AT-31	Command Decoder, Base Temp	0°	125°	83°	-25°	+150°
AT-32	Command Decoder, Internal Temp	0°	125°	86°	-20°	+155°
AT-33	Command Demodulator, VCO Temp	0°	125°	86°	-20°	+155°
AT-34	Power Distribution Unit, Base Temp	0°	140°	83°	-25°	+150°
AT-35	Power Distribution Unit, Internal Temp	10°	150°	100°	-10°	+180°
AT-36	PCU, Power Oscillator 1 Temp	0°	150°	94°	-20°	+172°
AT-37	PCU, Power Oscillator 2 Temp	-10°	165°	94°	-20°	+172°
AT-38	PCU, Regulator 1 Temp	50°	195°	103°	-20°	+210°
AT-39	PCU, Regulator 2 Temp	-10°	195°	103°	-20°	+210°
<u>Central Station Electrical</u>						
AE-1	0.25 Vdc Calibration	.24V	.26V	.25V	.22V	.28V
AE-2	4.75 Vdc Calibration	4.72V	4.78V	4.75V	4.70V	4.80V
AE-3	Converter Input Voltage	15.4V	16.9V	16.2V	15.0V	17.5V
AE-4	Converter Input Current	3.9A	4.5A	4.2A	3.8A	4.6A
AE-5	Shunt Regulator 1 Current	0.4A	2.7A	1.1A	0.05A	3.18A
AE-6	Shunt Regulator 2 Current	0.4A	2.7A	1.1A	0.1A	3.18A
AE-7	PCU Output Voltage 1 (29 V)	28.8V	29.2V	29.0V	28.59V	29.40V
AE-8	PCU Output Voltage 2 (15 V)	14.9V	15.36V	15.0V	14.8V	15.4V
AE-9	PCU Output Voltage 3 (12 V)	11.9V	12.05V	12.0V	11.85V	12.10V
AE-10	PCU Output Voltage 4 (5 V)	4.9V	5.15V	5.0V	4.85V	5.25V
AE-11	PCU Output Voltage 5 (-12 V)**	-12.35V	-11.9V	-12.0V	-12.4V	-11.8V
AE-12	PCU Output Voltage 6 (-6 V)**	-6.1V	-5.9V	-6.0V	-6.15V	-5.85V
AE-13	Receiver, Prelimiting Level	-92dbm	-84dbm	-88dbm	-101dbm	-61dbm*
AE-14	Receiver, Local Oscillator Level	2.6dbm	7.5dbm	6.1dbm	1.8dbm	7.6dbm*
AE-15	Transmitter A, AGC Voltage	1.47V	1.89V	1.10V	0.323V	5.00V
AE-16	Transmitter B, AGC Voltage	@-10°F	@+146°F	@75°F	0.26V	4.17V
AE-17	Transmitter A Power Doubler dc Current	1.5V	0.95V	0.61V	100ma*	240ma*
AE-18	Transmitter B Power Doubler dc Current	@-10°F	@+146°F	@75°F	100ma*	240ma*
		128ma	192ma	157ma		
		@-10°F	@146°F	@75°F		

*At 77.5°F

**AE-11 and AE-12 values also vary with changes of PCU output voltage 1 (29V), AE-7.

TABLE 6-X.- ALSEP 1 ANALOG CHANNEL USAGE - Concluded

Symbol	Location/Name	Nominal Operating Limits		Nom Oper Value	Redline Limits	
		Low	High		Low	High
<u>RTG Temperatures (Fahrenheit)</u>						
AR-1	Hot Frame 1 Temp	1000°	1120°	1054°	980°	1136°
AR-3	Hot Frame 3 Temp*	1000°	1120°	1107°	980°	1147°
AR-4	Cold Frame 1 Temp	405°	500°	478°	401°	545°
AR-5	Cold Frame 2 Temp*	415°	500°	426°	401°	545°
<u>Dust Detector</u>						
AX-1	Dust Cell 1 Temp (Fahrenheit)	110°	275°	136°	92°	320°
AX-2	Dust Cell 2 Temp (Fahrenheit)	110°	275°	136°	87°	320°
AX-3	Dust Cell 3 Temp (Fahrenheit)	110°	275°	136°	90°	320°
AX-4	Dust Cell 1 Output	3mV	80mV	52mV	1mV	163mV
AX-5	Dust Cell 2 Output	3mV	80mV	52mV	1mV	163mV
AX-6	Dust Cell 3 Output	3mV	80mV	52mV	1mV	163mV

Symbol	Location/Name	Channel	Operating Limits				
<u>Central Station Discrettes</u>			Decimal PCM				
AB-1	Command Demodulator 1 kHz Present	9	No modulation	0 to 76, no carrier 128 to 255			
AB-4	Power Distribution Experiment 1 and 2 Standby	12	Modulation	77 to 127			
			<u>Exper 1</u>	<u>Exper 2</u>			
			Standby-off	Standby-off	1 ± 1		
			Standby-on	Standby-off	72 ± 10		
			Standby-off	Standby-on	131 ± 10		
AB-5	Power Distribution Experiment 3, 4 and DSS Heater 2	14	Standby-on	Standby-on	192 ± 12		
			<u>Exper 3</u>	<u>Exper 4</u>	<u>DSS HTR 2</u>		
			Standby-off	Standby-off	Off	1 ± 1	
			Standby-off	Standby-off	On	35 ± 10	
			Standby-off	Standby-on	Off	69 ± 10	
			Standby-off	Standby-on	On	100 ± 10	
			Standby-on	Standby-off	Off	131 ± 10	
			Standby-on	Standby-off	On	160 ± 10	
			Standby-on	Standby-on	Off	188 ± 10	
			Standby-on	Standby-on	On	214 ± 10	
<u>Passive Seismic</u>							
AL-1	LP Amplifier Gain (X and Y)	23	Discrete				
AL-2	LP Amplifier Gain (Z)	38	Discrete	See			
AL-3	Level Direction and Speed	53	Discrete	Table			
AL-4	SP Amplifier Gain (Z)	68	Discrete	6-XI			
AL-5	Leveling Mode and Coarse Sensor Mode	24	Discrete	(PSE)			
AL-6	Thermal Control Status	39	Discrete	Page			
AL-7	Calibration Status LP and SP	54	Discrete	6-13			
AL-8	Uncage Status	69	Discrete				
<u>SIDE/CCGE</u>							
AI-1	LE Count Rate	70	0-5.0 V				
AI-2	HE Count Rate	85	0-5.0 V				

*Intermittent sensors.

TABLE 6-XI.- PASSIVE SEISMIC MEASUREMENTS LIST, ALSEP 1

Scientific Measurements

Symbol	Location/Measurement	ALSEP Word	ALSEP Frame	Sensor Range
DL- 1	Long Period X Seismic	9, 25, 41, 57	Every	1 mμ to 10μ
DL- 2	Long Period Y Seismic	11, 27, 43, 59	Every	1 mμ to 10μ
DL- 3	Long Period Z Seismic	13, 29, 45, 61	Every	1 mμ to 10μ
DL- 4	Long Period X Tidal	35	Even	.01 to 10" (arc)
DL- 5	Long Period Y Tidal	37	Even	.01 to 10" (arc)
DL- 6	Long Period Z Tidal	35	Odd	8 μgal to 8 mgal
DL- 7	Instrument Temp	37	Odd	107 - 143°F
DL- 8	Short Period Z Seismic	Every Even Word Except 2, 46, 56	Every	1 mμ to 10μ

Engineering Measurements

8 channels of Engineering Measurements included in ALSEP Word 33

Symbol	Location/Measurement	Analog Channel	Sensor Range	Decimal PCM	
AL- 1	LP Ampl Gain (X and Y)	23	0 db	0-0.4V	0-21
			-10db	0.6-1.4	31-72
			-20db	1.6-2.4	82-122
			-30db	2.6-4.0	133-204
AL- 2	LP Ampl Gain (Z)	38	0 db	0-0.4V	0-21
			-10db	0.6-1.4	31-72
			-20db	1.6-2.4	82-122
			-30db	2.6-4.0	133-204
AL- 3	Level Direction and Speed	53	+low	0-0.4V	0-21
			-low	0.6-1.4	31-72
			+high	1.6-2.4	82-122
			-high	2.6-4.0	133-204
AL- 4	SP Ampl Gain (Z)	68	0 db	0-0.4V	0-21
			-10db	0.6-1.4	31-72
			-20db	1.6-2.4	82-122
			-30db	2.6-4.0	133-204
AL- 5	Leveling Mode and Coarse Sensor Mode	24	Automatic, coarse sensor out	0-0.4V	0-21
			Forced, coarse sensor out	0.6-1.4	31-72
			Automatic, coarse sensor in	1.6-2.4	82-122
			Forced, coarse sensor in	2.6-4.0	133-204
AL- 6	Thermal Control	39	Automatic Mode ON	0-0.4V	0-21
			Automatic Mode OFF	0.6-1.4	31-72
			Forced Mode ON	1.6-2.4	82-122
			Forced Mode OFF	2.6-4.0	133-204
AL- 7	Calibration Status LP & SP	54	All ON	0-0.4V	0-21
			LP - ON, SP - OFF	0.6-1.4	31-72
			LP - OFF, SP - ON	1.6-2.4	82-122
			All OFF	2.6-4.0	133-204
AL- 8	Uncage Status	69	Caged	0-0.4V	0-21
			Arm	0.6-1.4	31-72
			Uncage	1.6-2.4	82-122

TABLE 6-XII.- LUNAR SURFACE MAGNETOMETER MEASUREMENTS LIST, ALSEP 1

Scientific Measurements

Symbol	Location/Measurement	ALSEP Word	Frame	Range
DM-25	LSM X-Axis Field	17,49	Every	+100,+200,+400 gamma
DM-26	LSM Y-Axis Field	19,51	Every	+100,+200,+400 gamma
DM-27	LSM Z-Axis Field	21,53	Every	+100,+200,+400 gamma

These data are in Words 17, 19, 21, 49, 51, 53 and have the following format:

2 ⁹	2 ⁸	2 ⁷	2 ⁶	2 ⁵	2 ⁴	2 ³	2 ²	2 ¹	2 ⁰
*Polarity Bit	Science Data								

*0 = Plus 1, 1 = Minus

Engineering Measurements

Housekeeping is located in ALSEP Word 5 which is subcommutated over 16 frames as follows:

Bit in Word 5	2 ⁹	2 ⁸	2 ⁷	2 ⁶	2 ⁵	2 ⁴	2 ³	2 ²	2 ¹	2 ⁰
Meaning	F	A1	A2	A3	A4	A5	A6	A7	B1	B2
		Engineering Data							Status Bits	

Where B1, B2 are bistable status data

A1,, A7 are bits derived from analog measurements

F locates the subcommutation start, F = 1 is Frame 1 of the subcommutation and F = 0 elsewhere.

Symbol	Location/Measurement	ALSEP Word	Frame	Sensor Range	
DM-1	Sensor X Temp	Eng. Data	5, 1,9	-30°C to +65°C	
DM-2	Sensor Y Temp		5, 2,10	-30°C to +65°C	
DM-3	Sensor Z Temp		5, 3,11	-30°C to +65°C	
DM-4	Base Temp		5, 4,12	-30°C to +65°C	
DM-5	Internal Temp		5, 5,13	-30°C to +65°C	
DM-6	Level Sensor 1		5, 6,14	-15° to +15° (arc)	
DM-7	Level Sensor 2		5, 7,15	-15° to +15° (arc)	
DM-8	Supply Voltage		5, 8,16	0 to +6.25Vdc	
DM-9	X Flip Position		5, 1	Discrete	2 status bits
DM-10	Y Flip Position		5, 2	Discrete	2 status bits
DM-11	Z Flip Position	5, 3	Discrete	2 status bits	
DM-12	X Gimbal Position	5, 4	Discrete	1 status bit	
DM-13	Y Gimbal Position	5, 4	Discrete	1 status bit	
DM-14	Z Gimbal Position	5, 5	Discrete	1 status bit	
DM-15	Thermal Control State	5, 5	Discrete	1 status bit	
DM-16	Measurement Range	5, 7	Discrete	2 status bits	
DM-17	X Offset Field	5, 9,10	Discrete	3 status bits	
DM-18	Y Offset Field	5, 10,11	Discrete	3 status bits	
DM-19	Z Offset Field	5, 12,13	Discrete	3 status bits	
DM-20	Scientific/Calibrate Mode	5, 13	Discrete	1 status bit	
DM-21	Offset Axis Address	5, 14	Discrete	2 status bits	
DM-22	Filter ON/OFF Status	5, 15	Discrete	1 status bit	
DM-23	Flip/Cal Inhibit Status	5, 15	Discrete	1 status bit	
DM-24	Filler Bits	5, 16	Discrete	2 status bits	
DM-28	Heater ON/OFF	5, 6	Discrete	1 status bit	
DM-29	Filler Bits	5, 6,8	Discrete	3 status bits	
DM-30	Frame Number	5	(Derived from F in Frame 1)		

TABLE 6-XIII.- LUNAR SURFACE MAGNETOMETER 16 POINT ENGINEERING SUBCOMMUTATION FORMAT AND ENGINEERING STATUS BIT STRUCTURE LOCATED IN ALSEP 1 MAIN FRAME, WORD 5

Frame Mark Bit	Engineering Parameter	Status Parameter	Subcommutation Frame	B ₁	B ₂	Status	
1	Sensor X Temp	X-axis Flip Position	1	0	0	Not at 0°, 90°, or 180° position 0° position 90° position 180° position	
		X-axis Flip Position	1	0	1		
		X-axis Flip Position	1	1	0		
		X-axis Flip Position	1	1	1		
0	Sensor Y Temp	Y-axis Flip Position	2	0	0	Not at 0°, 90°, or 180° position 0° position 90° position 180° position	
		Y-axis Flip Position	2	0	1		
		Y-axis Flip Position	2	1	0		
		Y-axis Flip Position	2	1	1		
0	Sensor Z Temp	Z-axis Flip Position	3	0	0	Not at 0°, 90°, or 180° position 0° position 90° position 180° position	
		Z-axis Flip Position	3	0	1		
		Z-axis Flip Position	3	1	0		
		Z-axis Flip Position	3	1	1		
0	Base Temp	X-axis Gimbal Position	4	1	1	Pre Site Survey Position Post Site Survey Position Pre Site Survey Position Post Site Survey Position	
		X-axis Gimbal Position	4	0			
		Y-axis Gimbal Position	4	1			
		Y-axis Gimbal Position	4	0			
0	Internal Temp	Z-axis Gimbal Position	5	1	1	Pre Site Survey Position Post Site Survey Position X-axis Control Y-axis Control/OFF	
		Z-axis Gimbal Position	5	0			
		Temp Control State	5	1			
		Temp Control State	5	0			
0	Level Sensor 1	Heater Power Status	6	1	1	Heater ON	
		Heater Power Status	6	1	0	Heater OFF	
0	Level Sensor 2	Measurement Range	7	0	0	100 γ Range	
		Measurement Range	7	1	0	200 γ Range	
		Measurement Range	7	1	1	400 γ Range	
		Measurement Range	7	0	1	Error	
0	Supply Voltage 1	Filler Bits	8	1	1	Not used	
0	Sensor X Temp	X-axis Field Offset	9	0	1	0% offset	
0	Sensor Y Temp	X-axis Field Offset	10	1	}	0% offset	
		X-axis Field Offset	9	1		0	-25% offset
		X-axis Field Offset	10	0		0	-25% offset
		X-axis Field Offset	9	1		0	-50% offset
		X-axis Field Offset	10	1		0	-50% offset
		X-axis Field Offset	9	1		1	-75% offset
		X-axis Field Offset	10	0		0	-75% offset
		X-axis Field Offset	9	0		0	+75% offset
		X-axis Field Offset	10	0		0	+75% offset
		X-axis Field Offset	9	0		0	+50% offset
		X-axis Field Offset	10	1		0	+50% offset
		X-axis Field Offset	9	0		1	+25% offset
		X-axis Field Offset	10	0		0	+25% offset
		Y-axis Field Offset	10	0		0	0% offset
		Y-axis Field Offset	11	1		1	0% offset
		0	Sensor Z Temp	Y-axis Field Offset		10	1
Y-axis Field Offset	11			0	0	-25% offset	
Y-axis Field Offset	10			0	1	-50% offset	
Y-axis Field Offset	11			0	1	-50% offset	
Y-axis Field Offset	10			1	1	-75% offset	
Y-axis Field Offset	11			1	0	-75% offset	
Y-axis Field Offset	10			0	0	+75% offset	
Y-axis Field Offset	11			0	0	+75% offset	
Y-axis Field Offset	10			0	0	+50% offset	
Y-axis Field Offset	11			0	1	+50% offset	
Y-axis Field Offset	10			0	0	+25% offset	
Y-axis Field Offset	11			1	0	+25% offset	
Z-axis Field Offset	12			0	1	0% offset	
Z-axis Field Offset	13			1	1	0% offset	
Z-axis Field Offset	12			1	0	-25% offset	
Z-axis Field Offset	13			0	0	-25% offset	
Z-axis Field Offset	12	1	0	-50% offset			
Z-axis Field Offset	13	1	1	-50% offset			
Z-axis Field Offset	12	1	1	-75% offset			
Z-axis Field Offset	13	0	0	-75% offset			
Z-axis Field Offset	12	0	0	+75% offset			
Z-axis Field Offset	13	0	0	+75% offset			
Z-axis Field Offset	12	0	0	+50% offset			
Z-axis Field Offset	13	1	0	+50% offset			
Z-axis Field Offset	12	0	1	+25% offset			
Z-axis Field Offset	13	0	0	+25% offset			
0	Base Temp	Scientific/Cal Mode	13	0	0	Calibrate ON	
		Scientific/Cal Mode	13	1	1	Calibrate OFF	
0	Level Sensor 1	Offset Axis Address	14	0	0	Not at X, Y, or Z	
		Offset Axis Address	14	1	0	X-axis position	
		Offset Axis Address	14	0	1	Y-axis position	
		Offset Axis Address	14	1	1	Z-axis position	
0	Level Sensor 2	Filter Status	15	1	1	Filter bypassed	
		Filter Status	15	0	1	Filter not bypassed	
		Flip/Cal Inhibit Status	15	1	1	Calibration Inhibited	
		Flip/Cal Inhibit Status	15	0	0	Calibration not inhibited	
0	Supply Voltage 1	Filler Bits	16	0	0	Not used	

TABLE 6-XIV.- SOLAR WIND SPECTROMETER (SWS) MEASUREMENTS LIST, ALSEP 1

NOTE: The SWS uses ALSEP Words 7, 23, 39 and 55 (in that order) to convey experiment data. The data is organized into 16 sequences of 186 words per sequence. Since the position of any element of data (Word) is indeterminate with respect to ALSEP Frames and Words, the channel designation is determined internally from information carried in the data. Therefore, in the following data, channel designation is not used but the data is identified by the SWS Word and by the first two bits (FB) which have been provided for Word identification within the sequence; and the sequence is identified by the Least Significant Bits (LSB) of Word 184 lying in the sequence being identified.

Basic Sequence, Repeated 16 times per cycle

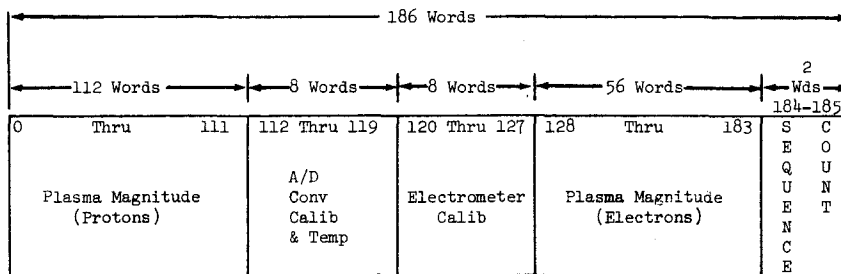

Typical Data Word

Cycle - Sequence Count Words

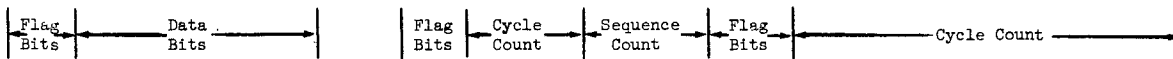
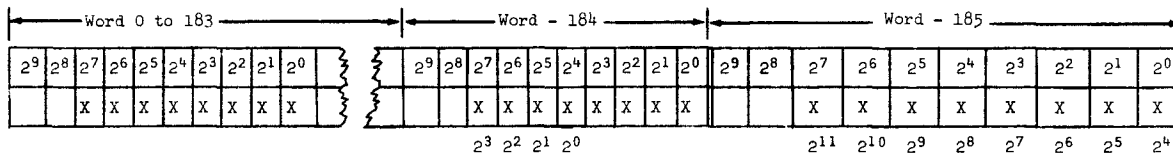

Flag Bits: 00 Scientific Data Word
 01 Calibration Data Word
 10 Sequence Counter Word

TABLE 6-XIV.- SOLAR WIND SPECTROMETER (SWS) MEASUREMENTS LIST, ALSEP 1 - Continued

SWS Sequences	Symbol	Location/Name	Flag Bit (FB)	SWS Word	Sensor Range
		<u>Science Data</u>			
		Plasma Magnitude (Positive Ions)			
		Subcommutated as follows: a reading is made of the sum of the outputs of the 7 Faraday cups and then there are 7 consecutive readings of the individual Faraday cups. This set of 8 is repeated for 14 different settings of the analyzer plate voltage.			
		<u>SWS Proton Flux</u>			
0-15; dc HiV Cal and ac HiV Cal in Sequence 14 and 15	DY- 1	Positive Ions - Sum - Lev 1	00	0	Log 0.4 to 6200 pA
	DY- 2	Positive Ions - Cup 1 - Lev 1	00	1	Log 0.4 to 6200 pA
	DY- 3	Positive Ions - Cup 2 - Lev 1	00	2	Log 0.4 to 6200 pA
	DY- 4	Positive Ions - Cup 3 - Lev 1	00	3	Log 0.4 to 6200 pA
	DY- 5	Positive Ions - Cup 4 - Lev 1	00	4	Log 0.4 to 6200 pA
	DY- 6	Positive Ions - Cup 5 - Lev 1	00	5	Log 0.4 to 6200 pA
	DY- 7	Positive Ions - Cup 6 - Lev 1	00	6	Log 0.4 to 6200 pA
	DY- 8	Positive Ions - Cup 7 - Lev 1	00	7	Log 0.4 to 6200 pA
	DY- 9	Positive Ions - Sum - Lev 2	00	8	Log 0.4 to 6200 pA
	DY-10	Positive Ions - Cup 1 - Lev 2	00	9	Log 0.4 to 6200 pA
	DY-11	Positive Ions - Cup 2 - Lev 2	00	10	Log 0.4 to 6200 pA
	DY-12	Positive Ions - Cup 3 - Lev 2	00	11	Log 0.4 to 6200 pA
	DY-13	Positive Ions - Cup 4 - Lev 2	00	12	Log 0.4 to 6200 pA
	DY-14	Positive Ions - Cup 5 - Lev 2	00	13	Log 0.4 to 6200 pA
	DY-15	Positive Ions - Cup 6 - Lev 2	00	14	Log 0.4 to 6200 pA
	DY-16	Positive Ions - Cup 7 - Lev 2	00	15	Log 0.4 to 6200 pA
	DY-17	Positive Ions - Sum - Lev 3	00	16	Log 0.4 to 6200 pA
	DY-18	Positive Ions - Cup 1 - Lev 3	00	17	Log 0.4 to 6200 pA
	DY-19	Positive Ions - Cup 2 - Lev 3	00	18	Log 0.4 to 6200 pA
	DY-20	Positive Ions - Cup 3 - Lev 3	00	19	Log 0.4 to 6200 pA
	DY-21	Positive Ions - Cup 4 - Lev 3	00	20	Log 0.4 to 6200 pA
	DY-22	Positive Ions - Cup 5 - Lev 3	00	21	Log 0.4 to 6200 pA
	DY-23	Positive Ions - Cup 6 - Lev 3	00	22	Log 0.4 to 6200 pA
	DY-24	Positive Ions - Cup 7 - Lev 3	00	23	Log 0.4 to 6200 pA
	DY-25	Positive Ions - Sum - Lev 4	00	24	Log 0.4 to 6200 pA
	DY-26	Positive Ions - Cup 1 - Lev 4	00	25	Log 0.4 to 6200 pA
	DY-27	Positive Ions - Cup 2 - Lev 4	00	26	Log 0.4 to 6200 pA
	DY-28	Positive Ions - Cup 3 - Lev 4	00	27	Log 0.4 to 6200 pA
	DY-29	Positive Ions - Cup 4 - Lev 4	00	28	Log 0.4 to 6200 pA
	DY-30	Positive Ions - Cup 5 - Lev 4	00	29	Log 0.4 to 6200 pA
	DY-31	Positive Ions - Cup 6 - Lev 4	00	30	Log 0.4 to 6200 pA
	DY-32	Positive Ions - Cup 7 - Lev 4	00	31	Log 0.4 to 6200 pA
	DY-33	Positive Ions - Sum - Lev 5	00	32	Log 0.4 to 6200 pA
	DY-34	Positive Ions - Cup 1 - Lev 5	00	33	Log 0.4 to 6200 pA
	DY-35	Positive Ions - Cup 2 - Lev 5	00	34	Log 0.4 to 6200 pA
	DY-36	Positive Ions - Cup 3 - Lev 5	00	35	Log 0.4 to 6200 pA
	DY-37	Positive Ions - Cup 4 - Lev 5	00	36	Log 0.4 to 6200 pA
	DY-38	Positive Ions - Cup 5 - Lev 5	00	37	Log 0.4 to 6200 pA
	DY-39	Positive Ions - Cup 6 - Lev 5	00	38	Log 0.4 to 6200 pA
	DY-40	Positive Ions - Cup 7 - Lev 5	00	39	Log 0.4 to 6200 pA
	DY-41	Positive Ions - Sum - Lev 6	00	40	Log 0.4 to 6200 pA
	DY-42	Positive Ions - Cup 1 - Lev 6	00	41	Log 0.4 to 6200 pA
	DY-43	Positive Ions - Cup 2 - Lev 6	00	42	Log 0.4 to 6200 pA
	DY-44	Positive Ions - Cup 3 - Lev 6	00	43	Log 0.4 to 6200 pA
	DY-45	Positive Ions - Cup 4 - Lev 6	00	44	Log 0.4 to 6200 pA
	DY-46	Positive Ions - Cup 5 - Lev 6	00	45	Log 0.4 to 6200 pA
	DY-47	Positive Ions - Cup 6 - Lev 6	00	46	Log 0.4 to 6200 pA
	DY-48	Positive Ions - Cup 7 - Lev 6	00	47	Log 0.4 to 6200 pA
	DY-49	Positive Ions - Sum - Lev 7	00	48	Log 0.4 to 6200 pA
	DY-50	Positive Ions - Cup 1 - Lev 7	00	49	Log 0.4 to 6200 pA
	DY-51	Positive Ions - Cup 2 - Lev 7	00	50	Log 0.4 to 6200 pA
	DY-52	Positive Ions - Cup 3 - Lev 7	00	51	Log 0.4 to 6200 pA
	DY-53	Positive Ions - Cup 4 - Lev 7	00	52	Log 0.4 to 6200 pA
	DY-54	Positive Ions - Cup 5 - Lev 7	00	53	Log 0.4 to 6200 pA
	DY-55	Positive Ions - Cup 6 - Lev 7	00	54	Log 0.4 to 6200 pA
	DY-56	Positive Ions - Cup 7 - Lev 7	00	55	Log 0.4 to 6200 pA
	DY-57	Positive Ions - Sum - Lev 8	00	56	Log 0.4 to 6200 pA
	DY-58	Positive Ions - Cup 1 - Lev 8	00	57	Log 0.4 to 6200 pA
	DY-59	Positive Ions - Cup 2 - Lev 8	00	58	Log 0.4 to 6200 pA
	DY-60	Positive Ions - Cup 3 - Lev 8	00	59	Log 0.4 to 6200 pA
	DY-61	Positive Ions - Cup 4 - Lev 8	00	60	Log 0.4 to 6200 pA

TABLE 6-XIV.- SOLAR WIND SPECTROMETER (SWS) MEASUREMENTS LIST, ALSEP 1 - Continued

SWS Sequences	Symbol	Location/Name	Flag Bit (FB)	SWS Word	Sensor Range	
0-15; dc HiV Cal and ac HiV Cal in Sequence 14 and 15	DY-62	Positive Ions - Cup 5 - Lev 8	00	61	Log 0.4 to 6200 pA	
	DY-63	Positive Ions - Cup 6 - Lev 8	00	62	Log 0.4 to 6200 pA	
	DY-64	Positive Ions - Cup 7 - Lev 8	00	63	Log 0.4 to 6200 pA	
	DY-65	Positive Ions - Sum - Lev 9	00	64	Log 0.4 to 6200 pA	
	DY-66	Positive Ions - Cup 1 - Lev 9	00	65	Log 0.4 to 6200 pA	
	DY-67	Positive Ions - Cup 2 - Lev 9	00	66	Log 0.4 to 6200 pA	
	DY-68	Positive Ions - Cup 3 - Lev 9	00	67	Log 0.4 to 6200 pA	
	DY-69	Positive Ions - Cup 4 - Lev 9	00	68	Log 0.4 to 6200 pA	
	DY-70	Positive Ions - Cup 5 - Lev 9	00	69	Log 0.4 to 6200 pA	
	DY-71	Positive Ions - Cup 6 - Lev 9	00	70	Log 0.4 to 6200 pA	
	DY-72	Positive Ions - Cup 7 - Lev 9	00	71	Log 0.4 to 6200 pA	
	DY-73	Positive Ions - Sum - Lev 10	00	72	Log 0.4 to 6200 pA	
	DY-74	Positive Ions - Cup 1 - Lev 10	00	73	Log 0.4 to 6200 pA	
	DY-75	Positive Ions - Cup 2 - Lev 10	00	74	Log 0.4 to 6200 pA	
	DY-76	Positive Ions - Cup 3 - Lev 10	00	75	Log 0.4 to 6200 pA	
	DY-77	Positive Ions - Cup 4 - Lev 10	00	76	Log 0.4 to 6200 pA	
	DY-78	Positive Ions - Cup 5 - Lev 10	00	77	Log 0.4 to 6200 pA	
	DY-79	Positive Ions - Cup 6 - Lev 10	00	78	Log 0.4 to 6200 pA	
	DY-80	Positive Ions - Cup 7 - Lev 10	00	79	Log 0.4 to 6200 pA	
	DY-81	Positive Ions - Sum - Lev 11	00	80	Log 0.4 to 6200 pA	
	DY-82	Positive Ions - Cup 1 - Lev 11	00	81	Log 0.4 to 6200 pA	
	DY-83	Positive Ions - Cup 2 - Lev 11	00	82	Log 0.4 to 6200 pA	
	DY-84	Positive Ions - Cup 3 - Lev 11	00	83	Log 0.4 to 6200 pA	
	DY-85	Positive Ions - Cup 4 - Lev 11	00	84	Log 0.4 to 6200 pA	
	DY-86	Positive Ions - Cup 5 - Lev 11	00	85	Log 0.4 to 6200 pA	
	DY-87	Positive Ions - Cup 6 - Lev 11	00	86	Log 0.4 to 6200 pA	
	DY-88	Positive Ions - Cup 7 - Lev 11	00	87	Log 0.4 to 6200 pA	
	DY-89	Positive Ions - Sum - Lev 12	00	88	Log 0.4 to 6200 pA	
	DY-90	Positive Ions - Cup 1 - Lev 12	00	89	Log 0.4 to 6200 pA	
	DY-91	Positive Ions - Cup 2 - Lev 12	00	90	Log 0.4 to 6200 pA	
	DY-92	Positive Ions - Cup 3 - Lev 12	00	91	Log 0.4 to 6200 pA	
	DY-93	Positive Ions - Cup 4 - Lev 12	00	92	Log 0.4 to 6200 pA	
	DY-94	Positive Ions - Cup 5 - Lev 12	00	93	Log 0.4 to 6200 pA	
	DY-95	Positive Ions - Cup 6 - Lev 12	00	94	Log 0.4 to 6200 pA	
	DY-96	Positive Ions - Cup 7 - Lev 12	00	95	Log 0.4 to 6200 pA	
	DZ- 1	Positive Ions - Sum - Lev 13	00	96	Log 0.4 to 6200 pA	
	DZ- 2	Positive Ions - Cup 1 - Lev 13	00	97	Log 0.4 to 6200 pA	
	DZ- 3	Positive Ions - Cup 2 - Lev 13	00	98	Log 0.4 to 6200 pA	
	DZ- 4	Positive Ions - Cup 3 - Lev 13	00	99	Log 0.4 to 6200 pA	
	DZ- 5	Positive Ions - Cup 4 - Lev 13	00	100	Log 0.4 to 6200 pA	
	DZ- 6	Positive Ions - Cup 5 - Lev 13	00	101	Log 0.4 to 6200 pA	
	DZ- 7	Positive Ions - Cup 6 - Lev 13	00	102	Log 0.4 to 6200 pA	
	DZ- 8	Positive Ions - Cup 7 - Lev 13	00	103	Log 0.4 to 6200 pA	
	DZ- 9	Positive Ions - Sum - Lev 14	00	104	Log 0.4 to 6200 pA	
	DZ-10	Positive Ions - Cup 1 - Lev 14	00	105	Log 0.4 to 6200 pA	
	DZ-11	Positive Ions - Cup 2 - Lev 14	00	106	Log 0.4 to 6200 pA	
	DZ-12	Positive Ions - Cup 3 - Lev 14	00	107	Log 0.4 to 6200 pA	
	DZ-13	Positive Ions - Cup 4 - Lev 14	00	108	Log 0.4 to 6200 pA	
	DZ-14	Positive Ions - Cup 5 - Lev 14	00	109	Log 0.4 to 6200 pA	
	DZ-15	Positive Ions - Cup 6 - Lev 14	00	110	Log 0.4 to 6200 pA	
	DZ-16	Positive Ions - Cup 7 - Lev 14	00	111	Log 0.4 to 6200 pA	
			Plasma Magnitude (Electrons)		128-183	Log 0.4 to 6200 pA
			Subcommutated in a manner similar to above except that here the set of 8 is repeated for 7 different settings of the analyzer plate voltage.			
			<u>SWS Electron Flux</u>			
		DZ-17	Electrons - Sum - Lev 15	00	128	Log 0.4 to 6200 pA
		DZ-18	Electrons - Cup 1 - Lev 15	00	129	Log 0.4 to 6200 pA
		DZ-19	Electrons - Cup 2 - Lev 15	00	130	Log 0.4 to 6200 pA
		DZ-20	Electrons - Cup 3 - Lev 15	00	131	Log 0.4 to 6200 pA
		DZ-21	Electrons - Cup 4 - Lev 15	00	132	Log 0.4 to 6200 pA
		DZ-22	Electrons - Cup 5 - Lev 15	00	133	Log 0.4 to 6200 pA
		DZ-23	Electrons - Cup 6 - Lev 15	00	134	Log 0.4 to 6200 pA
		DZ-24	Electrons - Cup 7 - Lev 15	00	135	Log 0.4 to 6200 pA
		DZ-25	Electrons - Sum - Lev 16	00	136	Log 0.4 to 6200 pA
		DZ-26	Electrons - Cup 1 - Lev 16	00	137	Log 0.4 to 6200 pA

TABLE 6-XIV.- SOLAR WIND SPECTROMETER (SWS) MEASUREMENTS LIST, ALSEP 1 - Continued

SWS Sequences	Symbol	Location/Name	Flag Bit (FB)	SWS Word	Sensor Range
0-15; dc HiV Cal and ac HiV Cal in Sequence 14 and 15	DZ-27	Electrons - Cup 2 - Lev 16	00	138	Log 0.4 to 6200 pA
	DZ-28	Electrons - Cup 3 - Lev 16	00	139	Log 0.4 to 6200 pA
	DZ-29	Electrons - Cup 4 - Lev 16	00	140	Log 0.4 to 6200 pA
	DZ-30	Electrons - Cup 5 - Lev 16	00	141	Log 0.4 to 6200 pA
	DZ-31	Electrons - Cup 6 - Lev 16	00	142	Log 0.4 to 6200 pA
	DZ-32	Electrons - Cup 7 - Lev 16	00	143	Log 0.4 to 6200 pA
	DZ-33	Electrons - Sum - Lev 17	00	144	Log 0.4 to 6200 pA
	DZ-34	Electrons - Cup 1 - Lev 17	00	145	Log 0.4 to 6200 pA
	DZ-35	Electrons - Cup 2 - Lev 17	00	146	Log 0.4 to 6200 pA
	DZ-36	Electrons - Cup 3 - Lev 17	00	147	Log 0.4 to 6200 pA
	DZ-37	Electrons - Cup 4 - Lev 17	00	148	Log 0.4 to 6200 pA
	DZ-38	Electrons - Cup 5 - Lev 17	00	149	Log 0.4 to 6200 pA
	DZ-39	Electrons - Cup 6 - Lev 17	00	150	Log 0.4 to 6200 pA
	DZ-40	Electrons - Cup 7 - Lev 17	00	151	Log 0.4 to 6200 pA
	DZ-41	Electrons - Sum - Lev 18	00	152	Log 0.4 to 6200 pA
	DZ-42	Electrons - Cup 1 - Lev 18	00	153	Log 0.4 to 6200 pA
	DZ-43	Electrons - Cup 2 - Lev 18	00	154	Log 0.4 to 6200 pA
	DZ-44	Electrons - Cup 3 - Lev 18	00	155	Log 0.4 to 6200 pA
	DZ-45	Electrons - Cup 4 - Lev 18	00	156	Log 0.4 to 6200 pA
	DZ-46	Electrons - Cup 5 - Lev 18	00	157	Log 0.4 to 6200 pA
	DZ-47	Electrons - Cup 6 - Lev 18	00	158	Log 0.4 to 6200 pA
	DZ-48	Electrons - Cup 7 - Lev 18	00	159	Log 0.4 to 6200 pA
	DZ-49	Electrons - Sum - Lev 19	00	160	Log 0.4 to 6200 pA
	DZ-50	Electrons - Cup 1 - Lev 19	00	161	Log 0.4 to 6200 pA
	DZ-51	Electrons - Cup 2 - Lev 19	00	162	Log 0.4 to 6200 pA
	DZ-52	Electrons - Cup 3 - Lev 19	00	163	Log 0.4 to 6200 pA
	DZ-53	Electrons - Cup 4 - Lev 19	00	164	Log 0.4 to 6200 pA
	DZ-54	Electrons - Cup 5 - Lev 19	00	165	Log 0.4 to 6200 pA
	DZ-55	Electrons - Cup 6 - Lev 19	00	166	Log 0.4 to 6200 pA
	DZ-56	Electrons - Cup 7 - Lev 19	00	167	Log 0.4 to 6200 pA
	DZ-57	Electrons - Sum - Lev 20	00	168	Log 0.4 to 6200 pA
	DZ-58	Electrons - Cup 1 - Lev 20	00	169	Log 0.4 to 6200 pA
	DZ-59	Electrons - Cup 2 - Lev 20	00	170	Log 0.4 to 6200 pA
	DZ-60	Electrons - Cup 3 - Lev 20	00	171	Log 0.4 to 6200 pA
	DZ-61	Electrons - Cup 4 - Lev 20	00	172	Log 0.4 to 6200 pA
	DZ-62	Electrons - Cup 5 - Lev 20	00	173	Log 0.4 to 6200 pA
	DZ-63	Electrons - Cup 6 - Lev 20	00	174	Log 0.4 to 6200 pA
	DZ-64	Electrons - Cup 7 - Lev 20	00	175	Log 0.4 to 6200 pA
	DZ-65	Electrons - Sum - Lev 21	00	176	Log 0.4 to 6200 pA
	DZ-66	Electrons - Cup 1 - Lev 21	00	177	Log 0.4 to 6200 pA
	DZ-67	Electrons - Cup 2 - Lev 21	00	178	Log 0.4 to 6200 pA
	DZ-68	Electrons - Cup 3 - Lev 21	00	179	Log 0.4 to 6200 pA
	DZ-69	Electrons - Cup 4 - Lev 21	00	180	Log 0.4 to 6200 pA
	DZ-70	Electrons - Cup 5 - Lev 21	00	181	Log 0.4 to 6200 pA
	DZ-71	Electrons - Cup 6 - Lev 21	00	182	Log 0.4 to 6200 pA
	DZ-72	Electrons - Cup 7 - Lev 21	00	183	Log 0.4 to 6200 pA

TABLE 6-XIV.- SOLAR WIND SPECTROMETER (SWS) MEASUREMENTS LIST, ALSEP 1 - Concluded

SWS Sequences	Symbol	Location/Name	Flag Bit (FB)	SWS Word	LSB's Word 184	PCM Count Low Gain	High Gain	
14	DW-55	Level #5	01	32	1110	68 ± 4	95 ± 4	
	DW-56	Level #6	01	40	1110	86 ± 4	112 ± 4	
	DW-57	Level #7	01	48	1110	103 ± 4	130 ± 4	
	DW-58	Level #8	01	56	1110	119 ± 4	163 ± 4	
	DW-59	Level #9	01	64	1110	136 ± 4	163 ± 4	
	DW-60	Level #10	01	72	1110	153 ± 4	189 ± 4	
	DW-61	Level #11	01	80	1110	170 ± 4	197 ± 4	
	DW-62	Level #12	01	88	1110	188 ± 4	215 ± 4	
	DW-63	Level #13	01	96	1110	205 ± 4	231 ± 4	
	DW-64	Level #14	01	104	1110	223 ± 4	247 ± 4	
	DW-65	Level #15 (Electron)	01	128	1110	016 ± 10	047 ± 10	
	DW-66	Level #16	01	136	1110	046 ± 7	075 ± 7	
	DW-67	Level #17	01	144	1110	082 ± 5	110 ± 5	
	DW-68	Level #18	01	152	1110	117 ± 4	144 ± 4	
	DW-69	Level #19	01	160	1110	152 ± 4	178 ± 4	
	DW-70	Level #20	01	168	1110	187 ± 4	214 ± 4	
	DW-71	Level #21	01	176	1110	222 ± 4	250 ± 4	
	ac HiV Calibrate, Repeated Once Every 16 SWS Sequences							
	15	DW-72	Level #1 (Proton)	01	0	1111	031 ± 3	052 ± 3
		DW-73	Level #2	01	8	1111	044 ± 3	064 ± 3
		DW-74	Level #3	01	16	1111	055 ± 3	076 ± 3
DW-75		Level #4	01	24	1111	069 ± 3	090 ± 3	
DW-76		Level #5	01	32	1111	082 ± 3	104 ± 3	
DW-77		Level #6	01	40	1111	095 ± 3	119 ± 3	
DW-78		Level #7	01	48	1111	111 ± 3	135 ± 3	
DW-79		Level #8	01	56	1111	126 ± 3	150 ± 3	
DW-80		Level #9	01	64	1111	141 ± 3	166 ± 3	
DW-81		Level #10	01	72	1111	157 ± 3	182 ± 3	
DW-82		Level #11	01	80	1111	173 ± 3	199 ± 3	
DW-83		Level #12	01	88	1111	190 ± 3	217 ± 3	
DW-84		Level #13	01	96	1111	207 ± 3	233 ± 3	
DW-85		Level #14	01	104	1111	224 ± 3	248 ± 3	
DW-86		Level #15 (Electron)	01	128	1111	038 ± 3	058 ± 3	
DW-87		Level #16	01	136	1111	063 ± 3	086 ± 3	
DW-88		Level #17	01	144	1111	092 ± 3	116 ± 3	
DW-89		Level #18	01	152	1111	123 ± 3	148 ± 3	
DW-90		Level #19	01	160	1111	155 ± 3	181 ± 3	
DW-91		Level #20	01	168	1111	189 ± 3	215 ± 3	
DW-92		Level #21	01	176	1111	224 ± 3	249 ± 3	

TABLE 6-XV.- LIMITS OF SWS ENGINEERING DATA

Symbol	Location/Name	Red Line Low	Nominal Low	Nominal	Nominal High	Redline High
DW-3	9mV A/D Calibration	1mV	8mV	9mV	10mV	20mV
DW-4	90mV A/D Calibration	50mV	80mV	90mV	100mV	150mV
DW-5	900mV A/D Calibration	500mV	800mV	900mV	1000mV	1500mV
DW-6	3000mV A/D Calibration	1650mV	2650mV	3000mV	3300mV	5000mV
DW-7	9000mV A/D Calibration	5000mV	8000mV	9000mV	9800mV	10,500mV
DW-11	Temperature, Mod 100	-25°C	-10°C	+25°C	+80°C	+100°C
DW-12	Temperature, Mod 200	-25°C	-10°C	+25°C	+80°C	+100°C
DW-13	Temperature, Mod 300	-25°C	-10°C	+25°C	+80°C	+100°C
DW-14	Temperature, Sensor Cup Assembly	-150°C	-101°C	+25°C	+93°C	+120°C
DW-15	Sun Angle Sensor	-1V	-.1V	0V	5.0V	9.8V
DW-16	Programer Voltage	4.0V	4.6V	4.95V	5.1V	6.0V
DW-17	Step Generator Voltage	.60V	.85V	.88V	.91V	1.2V
DW-18	Modulation Monitor	120 PCM	144 PCM	152 PCM	158 PCM	187 PCM

TABLE 6-XVI.- SUPRATHERMAL ION DETECTOR AND COLD CATHODE GAGE EXPERIMENT MEASUREMENTS LIST, ALSEP 1

ONE SIDE FRAME									
SIDE Word #1	SIDE Word #2	SIDE Word #3	SIDE Word #4	SIDE Word #5	SIDE Word #6	SIDE Word #7	SIDE Word #8	SIDE Word #9	SIDE Word #10
Data Address Counter	A/D Converter Voltage	A/D Converter Voltage	Digital Count Data MSD	Digital Count Data LSD	Status Subcom	A/D Converter Voltage	A/D Converter Voltage	Digital Count Data MSD	Digital Count Data LSD
ALSEP Word #15	ALSEP Word #31	ALSEP Word #47	ALSEP Word #56	ALSEP Word #63	ALSEP Word #15	ALSEP Word #31	ALSEP Word #47	ALSEP Word #56	ALSEP Word #63
← ALSEP EVEN FRAME →					← ALSEP ODD FRAME →				

SIDE Word #1 Provides identification of selected step in measurement program (SIDE frame count), a parity check of data in previous frame, and even frame identification.

Word #2 CCGE data and housekeeping data, subcommutated.

Word #3 Voltage on high-energy curved plate analyzer.

Word #4 and #5 Count data from high-energy curved plate analyzer.

Word #6 Various data subcommutated, such as command mode, command waiting for execution, range of electrometer, and ground plane grid voltage step; also, parity check of data in previous frame and odd frame identification.

Word #7 Velocity filter voltage.

Word #8 Voltage on low-energy curved plate analyzer.

Word #9 and #10 Count data from low-energy curved plate analyzer.

TABLE 6-XVI.- SUPRATHERMAL ION DETECTOR AND COLD CATHODE
GAGE EXPERIMENT MEASUREMENTS LIST, ALSEP 1 - Continued

Symbol	Location/Name	SIDE Frames	Sensor Range
Following measurements carried in ALSEP Word 15 even, SIDE Word 1 and in indicated SIDE Frames.			
DI-1	*SIDE Frame Counter	All	0-127 *7 bits 4 to 10 inclusive
Following measurements carried in ALSEP Word 31 even, SIDE Word 2 and in indicated SIDE Frames.			
DI-2	+5 volts analog	0,32,64,96	5 V \pm 0.15 V
DI-3	CCGE Science Data	1,3,5,7,9,41,73,105,121-127	
DI-4	Temp 1 (CCIG)	2,34,66,98	100 to 400°K
DI-5	Temp 2 (200 Blivet)	4,36,68,100	-90 to +125°C
DI-6	Temp 3 (500 Blivet)	6,38,70,102	-90 to +125°C
DI-7	4.5 kV	8,40,72,104	3.72 to 5.45 kV
DI-8	CCGE range	10,24,42,56,74,68,106,120	Range 1 6.9 to 9.0 V Range 2 4.2 to 5.7 V Range 3 2.2 to 3.2 V
DI-9	Temp 4 (100 Blivet)	11,43,75,107	-50 to +90°C
DI-10	Temp 5 (300 Blivet)	12,44,76,108	-50 to +90°C
DI-11	GND Plane voltage	13,15,29,31,45,47,61,63,69 77,79,93,95,109,111	
DI-12	Solar Cell	14,78	15 mV to 600 mV
DI-13	+60 volts	16,48,80,112	.15 to 150 V
DI-14	+30 volts	17,49,81,113	.15 to 150 V
DI-15	+5 volts digital	18,50,82,114	15 mV to 15 V
DI-16	Ground	19,51,83,115	0 to 18 mV
DI-17	-5 volts	20,52,84,116	-15 mV to -15 V
DI-18	-30 volts	21,53,85,117	-.15 to -150 V
DI-19	Temp 6 (800 Blivet)	22,54,86,118	-50 to +90°C
DI-20	-3.5 kV	23,55,87,119	-2.9 to -4.25 kV
DI-21	+1.0 volt cal.	27,59,91	15 mV to 15 V
DI-22	+30 mV cal.	25,57,89	15 mV to 15 V
DI-23	+A/D Ref. voltage	26,58,90	15 mV to 15 V
DI-24	Dust Cover and Seal	67,71	Preset 3.125 to 5.5 V Seal Only 1.875 to 3.125 Dust Cover Only .625 to 1.875 Cover and Seal 0 to .625
DI-25	-A/D Ref. volt	30,62,94	-15 mV to -15 V
DI-26	-1.0 volt cal.	37,101	-15 mV to -15 V
DI-27	-12 volt cal.	39,103	-15 mV to -15 V
DI-28	+12 volt cal.	28,60,92	15 mV to 15 V
DI-29	Pre Reg Duty Factor	65	68% to 100%
DI-30	-30 mV cal.	46,110	-15 mV to -15 V
DF-29	One Time Command Register Status	33,35,97,99	Preset 0 to .625V Seal Only .625 to 1.875V Dust Cover 1.875 to 3.125V Dust Cover and Seal 3.125 to 5.5V

*See note on page 6-25 for measurement content.

TABLE 6-XVI.- SUPRATHERMAL ION DETECTOR AND COLD CATHODE GAGE EXPERIMENT MEASUREMENTS LIST, ALSEP 1 - Continued

Symbol	Location/Name	SIDE Frame	Nominal Value
Following measurements carried in ALSEP Word 47 even, SIDE Word 3 and in indicated SIDE Frames.			
			<u>Voltage</u>
DI-40	HECPA Stepper Voltage	1,21,41,61,81,101	+437.5V
DI-41	HECPA Stepper Voltage	2,22,42,62,82,102	406.25V
DI-42	HECPA Stepper Voltage	3,23,43,63,83,103	375.0V
DI-43	HECPA Stepper Voltage	4,24,44,64,84,104	343.75V
DI-44	HECPA Stepper Voltage	5,25,45,65,85,105	312.5V
DI-45	HECPA Stepper Voltage	6,26,46,66,86,106	281.25V
DI-46	HECPA Stepper Voltage	7,27,47,67,87,107	250.0V
DI-47	HECPA Stepper Voltage	8,28,48,68,88,108	218.75V
DI-48	HECPA Stepper Voltage	9,29,49,69,89,109	187.5V
DI-49	HECPA Stepper Voltage	10,30,50,70,90,110	156.25V
DI-50	HECPA Stepper Voltage	11,31,51,71,91,111	93.75V
DI-51	HECPA Stepper Voltage	12,32,52,72,92,112	93.75V
DI-52	HECPA Stepper Voltage	13,33,53,73,93,113	62.5V
DI-53	HECPA Stepper Voltage	14,34,54,74,94,114	31.25V
DI-54	HECPA Stepper Voltage	15,35,55,75,95,115	12.5V
DI-55	HECPA Stepper Voltage	16,36,56,76,96,116	8.75V
DI-56	HECPA Stepper Voltage	17,37,57,77,97,117	6.25V
DI-57	HECPA Stepper Voltage	18,38,58,78,98,118	3.75V
DI-58	HECPA Stepper Voltage	19,39,59,79,99,119	2.5V
DI-59	HECPA Stepper Voltage	20,40,60,80,100,120	1.25V
DI-60	HECPA Stepper Voltage	0,121,122,123,124,125 126,127	0 V
Following measurements carried in ALSEP Word 56 even, SIDE Word 4 and in indicated SIDE Frames.			
DI-61	HE Data - MSD*	All	0 to 999 decimal
*MSD - Most significant data.			
Following measurements carried in ALSEP Word 63 even, SIDE Word 5 and in indicated SIDE Frames.			
DI-62	HE Data - LSD**	All	0 to 999 decimal
**LSD - Least significant data.			

TABLE 6-XVI.- SUPRATHERMAL ION DETECTOR AND COLD CATHODE GAGE EXPERIMENT MEASUREMENTS LIST, ALSEP 1 - Continued

Symbol	Location/Name	SIDE Frame	Decimal Count
Following measurements carried in ALSEP Word 15 odd, SIDE Word 6, and in indicated SIDE Frames, bits 4 to 10 inclusive.*			
DI-63	Ground Plane Step	0,2,4,6,8,10,12,14,16 18,20,22,24,26,28,30 32,34,36,38,40,42,44,46,48 50,52,54,56,58,60,62,64, 66,68,70,72,74,76,78,80 82,84,86,88,90,92,94,96, 98,100,102,104,106,108,110 112,114,116,118	24 steps 0 - 11 16 - 27
DI-64	Command Register	1,5,13,17,21,29,33,37,45,49 53,61,65,69,77,81,85,93,97 101,109,113,117,125	0 to 15
DI-65	Mode Register	3,11,15,19,23,27,31,35,43,47 51,55,59,63,67,75,79,83,87 91,95,99,107,111,115,119	0 to 14
DI-66	Dust Cover and Seal	7,39,71,103	Dust Cover and Seal Blown -3 Seal Only -1 Dust Cover Only -2 Reset -3
DI-67	CCGE Electrometer Range	9,25,41,57,73,89,105	Range #1 - 0 Range #2 - 2 Range #3 - 3
DI-68	Cal Rate #1	120,124	<u>SIDE Word 4,5</u> <u>SIDE Word 9,10</u> 0 632800 ± 14000 2 ± 2
DI-69	Cal Rate #2	121	1 2 ± 2 154 ± 4
DI-70	Cal Rate #3	122,126	2 154 ± 4 19775 ± 400
DI-71	Cal Rate #4	123,127	3 19775 ± 400 632800 ± 14000

*SIDE Words 1 and 6 measurement content shown below

2 ⁹	2 ⁸	2 ⁷	2 ⁶	2 ⁵	2 ⁴	2 ³	2 ²	2 ¹	2 ⁰
P	F ₁	F ₂	A ₁	A ₂	A ₃	A ₄	A ₅	A ₆	A ₇

P Parity

F Frame ID

A Data (LSB in A₇)

DF-7	SIDE Parity	In SIDE Word 1 and 6, all frames
DF-8	SIDE Frame ID	In SIDE Word 1 and 6, all frames.

"1" odd number of ones
in previous ALSEP frame.
"0" even number of ones
in previous ALSEP frame.
00 even ALSEP frame.
11 odd ALSEP frame.

TABLE 6-XVI.- SUPRATHERMAL ION DETECTOR AND COLD CATHODE
GAGE EXPERIMENT MEASUREMENTS LIST, ALSEP 1 - Continued

Symbol	Location/Name	SIDE Frame		Nominal Value
Following measurements carried in ALSEP Word 31 odd, SIDE Word 7 and in indicated SIDE Frames.				
		<u>Normal Mode</u>	<u>Reset @9</u>	<u>Voltage</u>
DI-72	Velocity Filter Voltage	0	0,60	29.0 V
DI-73	Velocity Filter Voltage	1	1,61	26.3
DI-74	Velocity Filter Voltage	2	2,62	23.8
DI-75	Velocity Filter Voltage	3	3,63	21.4
DI-76	Velocity Filter Voltage	4	4,64	19.2
DI-77	Velocity Filter Voltage	5	5,65	17.1
DI-78	Velocity Filter Voltage	6	6,66	14.5
DI-79	Velocity Filter Voltage	7	7,67	13.3
DI-80	Velocity Filter Voltage	8	8,68	11.6
DI-81	Velocity Filter Voltage	9	9,69	10.0
DI-82	Velocity Filter Voltage	10		8.59
DI-83	Velocity Filter Voltage	11		7.30
DI-84	Velocity Filter Voltage	12		6.40
DI-85	Velocity Filter Voltage	13		5.13
DI-86	Velocity Filter Voltage	14		4.25
DI-87	Velocity Filter Voltage	15		3.50
DI-88	Velocity Filter Voltage	16		2.89
DI-89	Velocity Filter Voltage	17		2.41
DI-90	Velocity Filter Voltage	18		2.07
DI-91	Velocity Filter Voltage	19		1.87
DI-92	Velocity Filter Voltage	20	10,70	16.7
DI-93	Velocity Filter Voltage	21	11,71	15.2
DI-94	Velocity Filter Voltage	22	12,72	13.7
DI-95	Velocity Filter Voltage	23	13,73	12.4
DI-96	Velocity Filter Voltage	24	14,74	11.1
DI-97	Velocity Filter Voltage	25	15,75	9.86
DI-98	Velocity Filter Voltage	26	16,76	8.36
DI-99	Velocity Filter Voltage	27	17,77	7.66
DJ-0	Velocity Filter Voltage	28	18,78	6.68
DJ-1	Velocity Filter Voltage	29	19,79	5.78
DJ-2	Velocity Filter Voltage	30		4.96
DJ-3	Velocity Filter Voltage	31		4.21
DJ-4	Velocity Filter Voltage	32		3.69
DJ-5	Velocity Filter Voltage	33		2.96
DJ-6	Velocity Filter Voltage	34		2.45
DJ-7	Velocity Filter Voltage	35		2.02
DJ-8	Velocity Filter Voltage	36		1.67
DJ-9	Velocity Filter Voltage	37		1.39
DJ-10	Velocity Filter Voltage	38		1.20
DJ-11	Velocity Filter Voltage	39		1.08
DJ-12	Velocity Filter Voltage	40	20,80	9.65
DJ-13	Velocity Filter Voltage	41	21,81	8.77
DJ-14	Velocity Filter Voltage	42	22,82	7.93
DJ-15	Velocity Filter Voltage	43	23,83	7.14
DJ-16	Velocity Filter Voltage	44	24,84	6.39
DJ-17	Velocity Filter Voltage	45	25,85	5.69
DJ-18	Velocity Filter Voltage	46	26,86	4.83

TABLE 6-XVI.- SUPRATHERMAL ION DETECTOR AND COLD CATHODE
 GAGE EXPERIMENT MEASUREMENTS LIST, ALSEP 1 - Continued

Symbol	Location/Name	SIDE Frame		Nominal Value
		Normal Mode	Reset #9	Voltage
DJ-19	Velocity Filter Voltage	47	27,87	4.42 V
DJ-20	Velocity Filter Voltage	48	28,88	3.86
DJ-21	Velocity Filter Voltage	49	29,89	3.34
DJ-22	Velocity Filter Voltage	50		2.86
DJ-23	Velocity Filter Voltage	51		2.43
DJ-24	Velocity Filter Voltage	52		2.13
DJ-25	Velocity Filter Voltage	53		1.71
DJ-26	Velocity Filter Voltage	54		1.42
DJ-27	Velocity Filter Voltage	55		1.17
DJ-28	Velocity Filter Voltage	56		0.963
DJ-29	Velocity Filter Voltage	57		0.805
DJ-30	Velocity Filter Voltage	58		0.691
DJ-31	Velocity Filter Voltage	59		0.624
DJ-32	Velocity Filter Voltage	60	30,90	5.57
DJ-33	Velocity Filter Voltage	61	31,91	5.06
DJ-34	Velocity Filter Voltage	62	32,92	4.58
DJ-35	Velocity Filter Voltage	63	33,93	4.12
DJ-36	Velocity Filter Voltage	64	34,94	3.69
DJ-37	Velocity Filter Voltage	65	35,95	3.29
DJ-38	Velocity Filter Voltage	66	36,96	2.79
DJ-39	Velocity Filter Voltage	67	37,97	2.55
DJ-40	Velocity Filter Voltage	68	38,98	2.23
DJ-41	Velocity Filter Voltage	69	39,99	1.93
DJ-42	Velocity Filter Voltage	70		1.65
DJ-43	Velocity Filter Voltage	71		1.40
DJ-44	Velocity Filter Voltage	72		1.23
DJ-45	Velocity Filter Voltage	73		0.987
DJ-46	Velocity Filter Voltage	74		0.817
DJ-47	Velocity Filter Voltage	75		0.673
DJ-48	Velocity Filter Voltage	76		0.556
DJ-49	Velocity Filter Voltage	77		0.464
DJ-50	Velocity Filter Voltage	78		0.399
DJ-51	Velocity Filter Voltage	79		0.360
DJ-52	Velocity Filter Voltage	80	40,100	3.22
DJ-53	Velocity Filter Voltage	81	41,101	2.92
DJ-54	Velocity Filter Voltage	82	42,102	2.64
DJ-55	Velocity Filter Voltage	83	43,103	2.38
DJ-56	Velocity Filter Voltage	84	44,104	2.13
DJ-57	Velocity Filter Voltage	85	45,105	1.90
DJ-58	Velocity Filter Voltage	86	46,106	1.61
DJ-59	Velocity Filter Voltage	87	47,107	1.47
DJ-60	Velocity Filter Voltage	88	48,108	1.29
DJ-61	Velocity Filter Voltage	89	49,109	1.11
DJ-62	Velocity Filter Voltage	90		0.954
DJ-63	Velocity Filter Voltage	91		0.811
DJ-64	Velocity Filter Voltage	92		0.710
DJ-65	Velocity Filter Voltage	93		0.570
DJ-66	Velocity Filter Voltage	94		0.472

TABLE 6-XVI.- SUPRATHERMAL ION DETECTOR AND COLD CATHODE
GAGE EXPERIMENT MEASUREMENTS LIST, ALSEP 1 - Concluded

Symbol	Location/Name	SIDE Frame		Nominal Value
		Normal Mode	Reset @9	Voltage
DJ-67	Velocity Filter Voltage	95		0.389
DJ-68	Velocity Filter Voltage	96		0.321
DJ-69	Velocity Filter Voltage	97		0.268
DJ-70	Velocity Filter Voltage	98		0.230
DJ-71	Velocity Filter Voltage	99		0.208
DJ-72	Velocity Filter Voltage	100	50,110	1.86
DJ-73	Velocity Filter Voltage	101	51,111	1.69
DJ-74	Velocity Filter Voltage	102	52,112	1.53
DJ-75	Velocity Filter Voltage	103	53,113	1.37
DJ-76	Velocity Filter Voltage	104	54,114	1.23
DJ-77	Velocity Filter Voltage	105	55,115	1.10
DJ-78	Velocity Filter Voltage	106	56,116	0.930
DJ-79	Velocity Filter Voltage	107	57,117	0.851
DJ-80	Velocity Filter Voltage	108	58,118	0.743
DJ-81	Velocity Filter Voltage	109	59,119	0.642
DJ-82	Velocity Filter Voltage	110		0.551
DJ-83	Velocity Filter Voltage	111		0.468
DJ-84	Velocity Filter Voltage	112		0.409
DJ-85	Velocity Filter Voltage	113		0.329
DJ-86	Velocity Filter Voltage	114		0.272
DJ-87	Velocity Filter Voltage	115		0.224
DJ-88	Velocity Filter Voltage	116		0.185
DJ-89	Velocity Filter Voltage	117		0.155
DJ-90	Velocity Filter Voltage	118		0.133
DJ-91	Velocity Filter Voltage	119		0.120
DJ-92	Velocity Filter Voltage	120	120	29.0
DJ-93	Velocity Filter Voltage	121	121	26.3
DJ-94	Velocity Filter Voltage	122	122	23.8
DJ-95	Velocity Filter Voltage	123	123	21.4
DJ-96	Velocity Filter Voltage	124	124	19.2
DJ-97	Velocity Filter Voltage	125,126,127	125,126,127	>29.0
Following measurements carried in ALSEP Word 47 odd, SIDE Word 8 and in indicated SIDE Frames.				
		<u>Normal Mode</u>	<u>Reset Vel Filter @9</u>	<u>Voltage</u>
DJ-98	LECPA Stepper Voltage	0-19	0-9,60-69	12.15 V
DJ-99	LECPA Stepper Voltage	20-39	10-19,70-79	4.050
DF-0	LECPA Stepper Voltage	40-59	20-29,80-89	1.35
DF-1	LECPA Stepper Voltage	60-79	30-39,90-99	0.450
DF-2	LECPA Stepper Voltage	80-99	40-49,100-109	0.150
DF-3	LECPA Stepper Voltage	100-119	50-59,110-119	0.050
DF-4	LECPA Stepper Voltage	120-127	120-127	0 V
Following measurements carried in ALSEP Word 56 odd, SIDE Word 9 and in indicated SIDE Frames.				
DF-5	LE Data - MSD	All		0 to 999 decimal
Following measurements carried in ALSEP Word 63 odd, SIDE Word 10 and in indicated SIDE Frames.				
DF-6	LE Data - LSD	All		0 to 999 decimal
Two SIDE measurements are included in ALSEP Housekeeping Word 33				
		<u>Channel</u>		
AI-1	LE Count Rate	70		0 - 5.0 Vdc
AI-2	HE Count Rate	85		0 - 5.0 Vdc

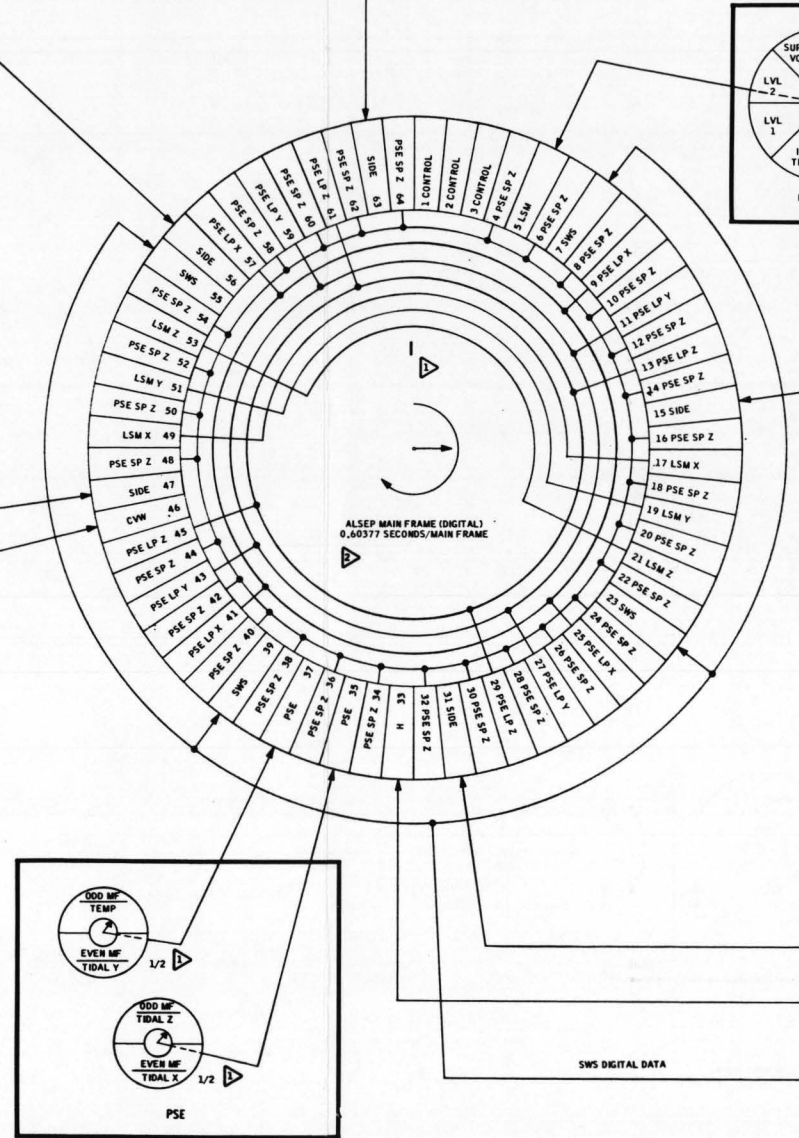
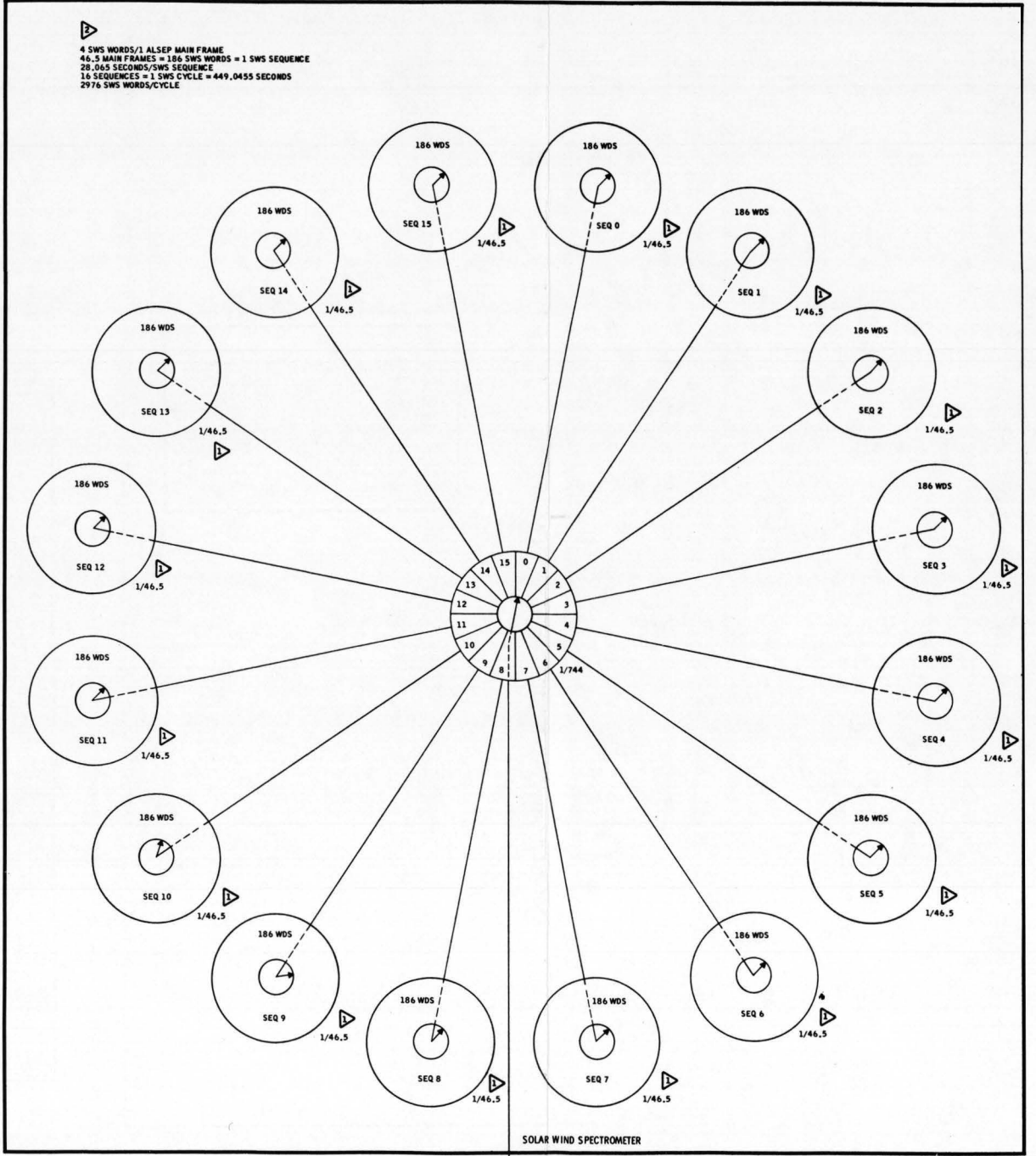
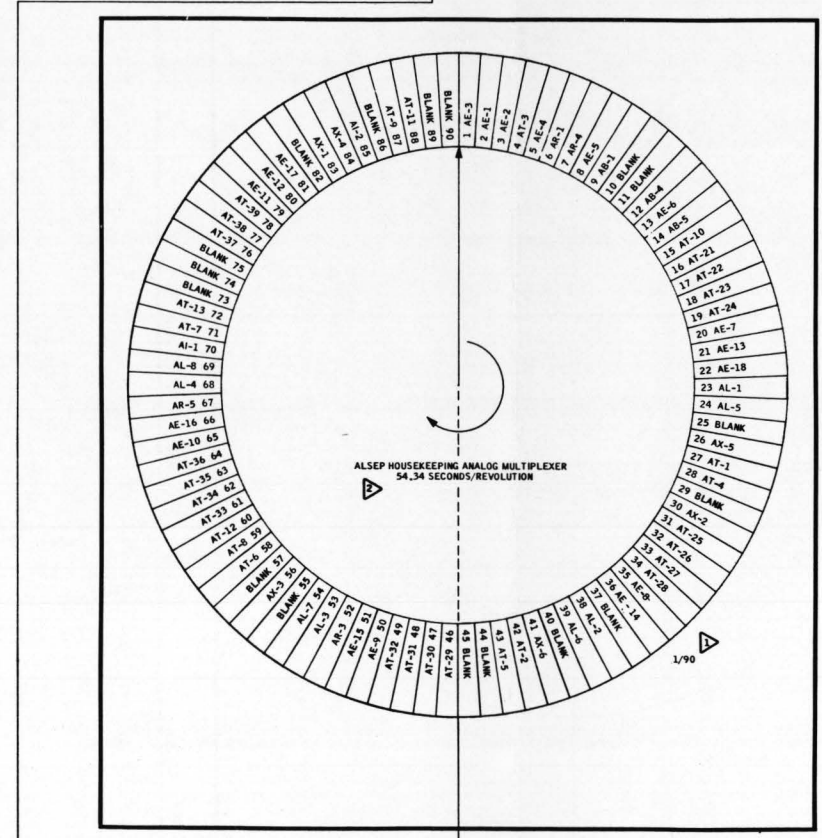
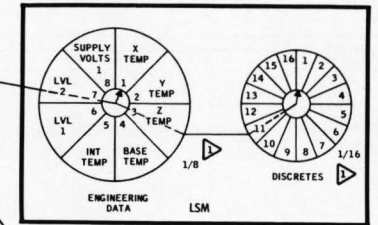
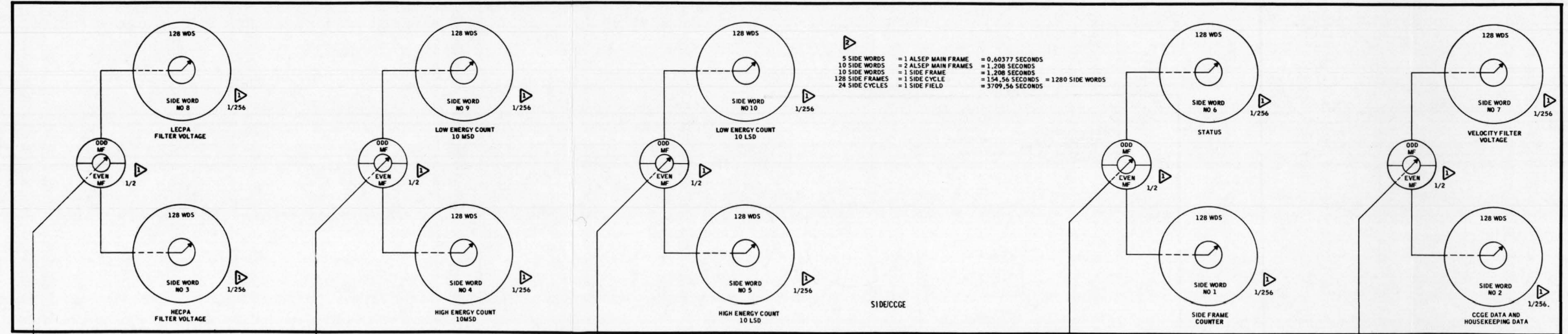

COMMAND DECODER

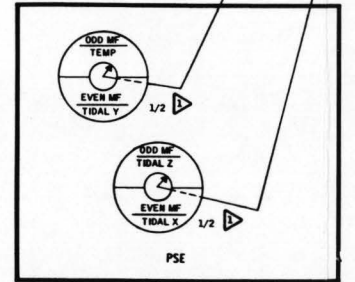

A/D CONVERTER

NOTES:
 ▲ TIMES ARE FOR NORMAL BIT RATE (1000 BPS).
 ▲ NUMBERS ARE RELATIONS TO ALSEP MAIN FRAME RATE.
 EXAMPLE:
 WHEN THE ALSEP MAIN FRAME COMPLETES ONE REVOLUTION, ALSEP HOUSEKEEPING ANALOG MIX TURNS 1/90 OF A REVOLUTION.

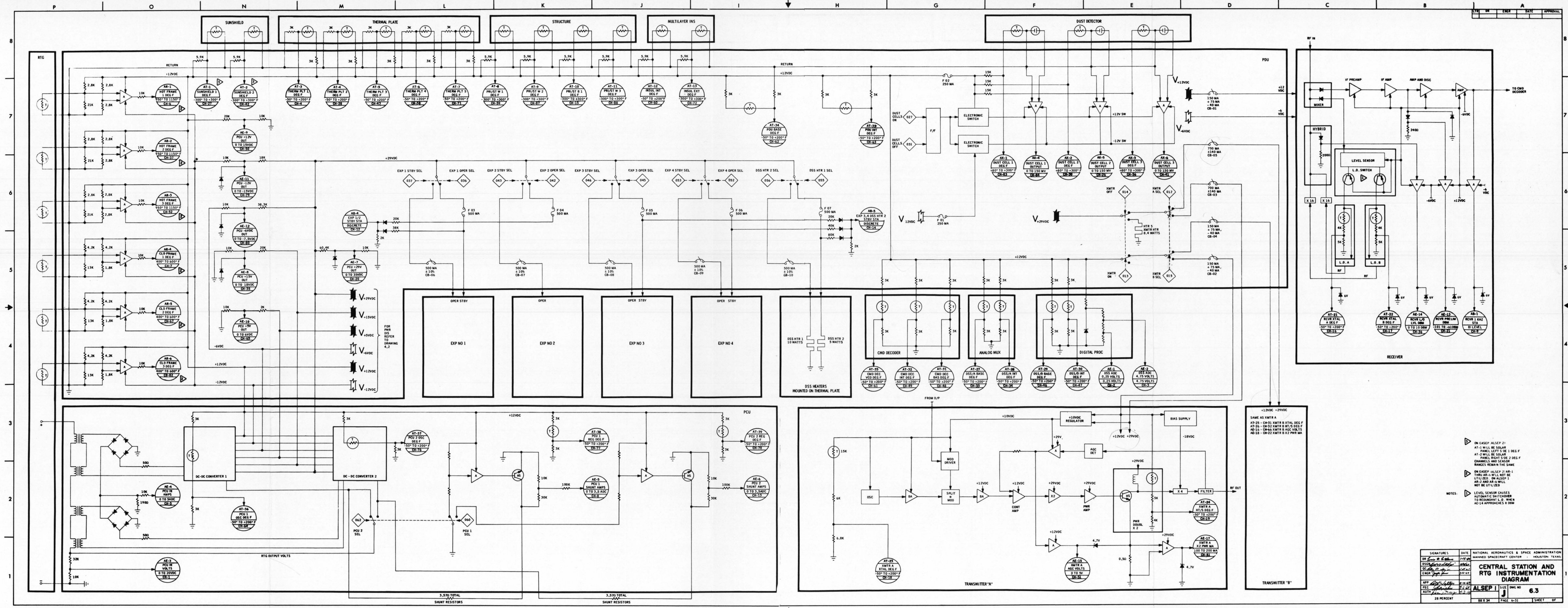

NOTES:

- ON CASEP (ALSEP 2): AT-1 WILL BE SOLAR PANEL LEFT SIDE 1 DEG F AT-3 WILL BE SOLAR PANEL RIGHT SIDE 2 DEG F CHANNELS AND SENSOR RANGES REMAIN THE SAME
- ON CASEP (ALSEP 2): AR-1 THRU AR-6 WILL NOT BE UTILIZED. ON ALSEP 1 NOT BE UTILIZED
- LEVEL SENSOR CAUSES AUTOMATIC SWITCHOVER TO REDUNDANT L.O. WHEN AE-14 APPROACHES 8 DBM

7 DUST DETECTOR
SUBSYSTEM

SECTION 7
DUST DETECTOR SYBSYSTEM

7.1 SYSTEM DESCRIPTION

The objectives of the dust detector are to obtain data for assessment of dust accretion on the ALSEP and to provide a measure of thermal degradation of thermal surfaces.

Dust accumulation on the surfaces of the three solar cells will reduce the amount of solar illumination detected by the cells. The outputs of the three solar cells are applied to three amplifiers which condition the signals and apply them to three subcommutated analog data channels of the data subsystem.

Temperature at each solar cell, essential to the analysis of cell output data, is monitored by a thermistor to obtain thermal data in relation to dust accretion. The thermistor outputs are applied to three subcommutated analog data channels of the data subsystem.

The expected temperature range of each solar cell will be -300°F to $+300^{\circ}\text{F}$ over a lunar cycle, and the temperature readings will only be usable above $+80^{\circ}\text{F}$ because of calibration difficulties. However, during the lunar night when the dust detector will be turned off, the voltage to the three temperature sensors (AX1, AX2, and AX3) will not be turned off, and the output voltages will be greater than +5V (between +5V and +12V) and will therefore be meaningless. This will occur with temperatures below $+80^{\circ}\text{F}$ and will cause the A-D multiplexer to give an all 1's readout.

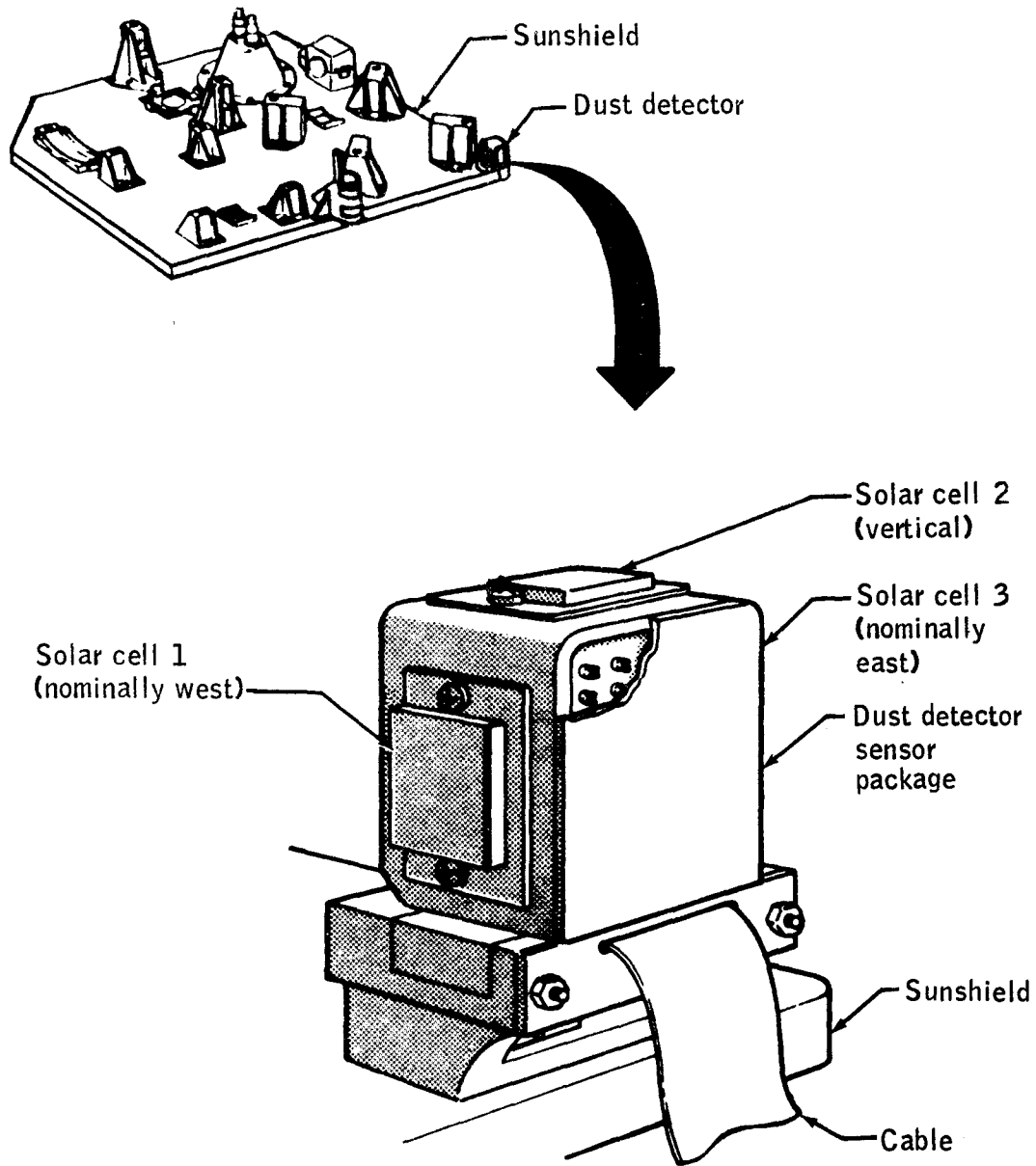
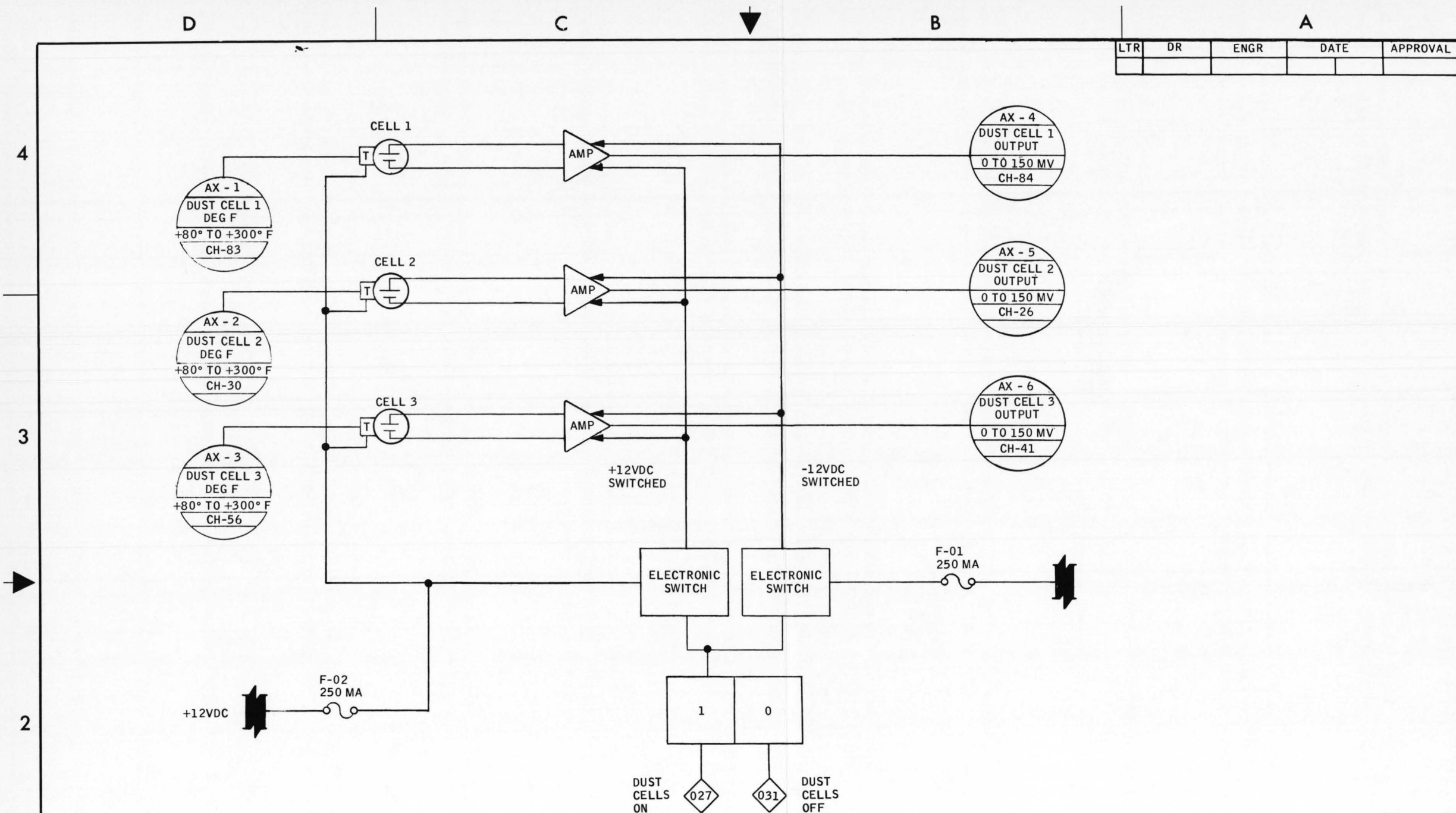

Figure 7-1.- Dust detector.

LTR	DR	ENGR	DATE	APPROVAL



NOTE:

VOLTAGE BUS	POWER	CURRENT	CIRCUIT PROTECTION
-12	160 MW	13.3 MA	F-01 250 MA
+12	380 MW	31.7 MA	F-02 250 MA

A BLOWN FUSE F-01 WILL PERMANENTLY DISABLE THE DUST DETECTOR, RESULTING IN LOSS OF PHOTOELECTRIC CELL VOLTAGE TM PARAMETERS AX-4, AX-5 AND AX-6

A BLOWN FUSE F-02 WILL PERMANENTLY DISABLE THE DUST DETECTOR, RESULTING IN LOSS OF PHOTOELECTRIC CELL VOLTAGE TM PARAMETERS AX-4, AX-5 AND AX-6 AND PHOTOELECTRIC CELL TEMPERATURE TM PARAMETERS AX-1, AX-2 AND AX-3

SIGNATURES		DATE	NATIONAL AERONAUTICS & SPACE ADMINISTRATION MANNED SPACECRAFT CENTER · HOUSTON, TEXAS	
DR Louis R. LeBlanc		1/8/69	DUST DETECTOR SCHEMATIC	
DSGN <i>[Signature]</i>		2/4/69		
QC <i>[Signature]</i>		2-14-69		
ENGR Joseph James		8-21-69		
APP <i>[Signature]</i>		4-2-69		
FEC Ray B. Fisher		4-2-69		
AUTH <i>[Signature]</i>		4-2-69		
55.9 PERCENT			ALSEP I	SIZE DWG NO C 7.1
			22 X 17	PAGE 7-3 SHEET OF

8 PASSIVE
SEISMIC
EXPERIMENT

SECTION 8

PASSIVE SEISMIC EXPERIMENT (SO 31)

8.1 SYSTEM DESCRIPTION

The Passive Seismic Experiment (PSE) provides data on lunar seismic activity and the properties of the lunar interior. The PSE does this by monitoring the long-period, low-frequency and the short-period, high-frequency energy associated with lunar quakes as well as measuring the direction and the distance to the seismic epicenters.

Physically, the PSE consists of two parts, both included in one package. The long-period instrument, which contains three seismometers (one vertical and two horizontal, placed orthogonally to each other), measures long-period, low-frequency seismic energy with a period of 250 to 0.3 seconds. This instrument measures the distance and direction to a seismic quake, as well as the long-term tidal deformations of the moon. The short-period instrument functions as a velocity transducer which measures short-period (5 to .04 seconds), high-frequency (up to 25 cycles per second) seismic energy with very high sensitivity. The instrument consists of a moving-magnet mass built so that a transducer can measure the velocity of the magnet. The displacements and the velocity of these instruments are measured, amplified, and filtered in a series of electronic circuits which produce an output signal to the central station data processor.

When the PSE is deployed by the crew, it must be leveled to within ± 5 degrees. Within the instrument case, the seismic elements are mounted on gimbals having leveling motors which can level from an initial tilt as great as 5 degrees. By using a combination of "coarse-level" sensors and the horizontal seismometers, the PSE can be leveled on command to within 3 arc seconds.

TABLE 8-1.- PRESET CONDITIONS

"Preset" is defined as the logic condition initialized by activation of the experiment.

Command	Function	Presets To	Lunar Deployment Condition
037	EXP 1 STBY SEL		EXP IN STBY
063	PSE/XY GAIN CH	-30db	
064	PSE/Z GAIN CH	-30db	
065	PSE/SP CAL CH	OFF	
066	PSE/LF CAL CH	OFF	
067	PSE/SP GAIN CH	-30db	
070	LVL MTRX ON/OFF	OFF	
071	LVL MTRY ON/OFF	OFF	
072	LVL MERZ ON/OFF	OFF	
073	UNCAGE ARM/FIRE	CAGED	
074	LVL DIR POS/NEG	POS	
075	LVL SPEED HI/LO	LOW	
076	PSE T CTL CH	AUTO ON	
101	PSE FILT IN/OUT	OUT	
102	LVL SNSR IN/OUT	OUT	
103	PSE LVL MDE A/F	AUTO	

The PSE will normally be leveled using the AUTO leveling mode (refer to Table 8-1 for the preset conditions) with the forced mode as a backup method. The coarse sensors (utilized only in the X and Y axes) will be commanded IN for the initial leveling sequence. The coarse sensors are effective in the AUTO mode only and provide the X- or Y-axis leveling motor drive signals when there exists an off level condition greater than 8 minutes of arc. At this point the axes' tidal outputs provide the leveling motor drive signals to control leveling to the final level condition.

TABLE 8-II.- LEVELING RATES

	<u>X or Y</u>	<u>Z</u>
<u>FORCED MODE</u>		
High Speed	152 to 305 μ rad/sec	20 to 40 mgal/sec
Low Speed	5.1 to 17.7 μ rad/sec	.67 to 2.34 mgal/sec
<u>AUTOMATIC MODE</u>		
Coarse Sensor In (off level >8 min of arc)	152 to 305 μ rad/sec	No coarse sensor on Z-axis. Use forced mode.
Coarse Sensor Out (tidal output saturated)	3.8 to 7.6 μ rad/sec	0.5 to 1.0 mgal/sec
Coarse Sensor Out (tidal data unsaturated)	0 to 3.8 μ rad/sec	0 to 1.0 mgal/sec

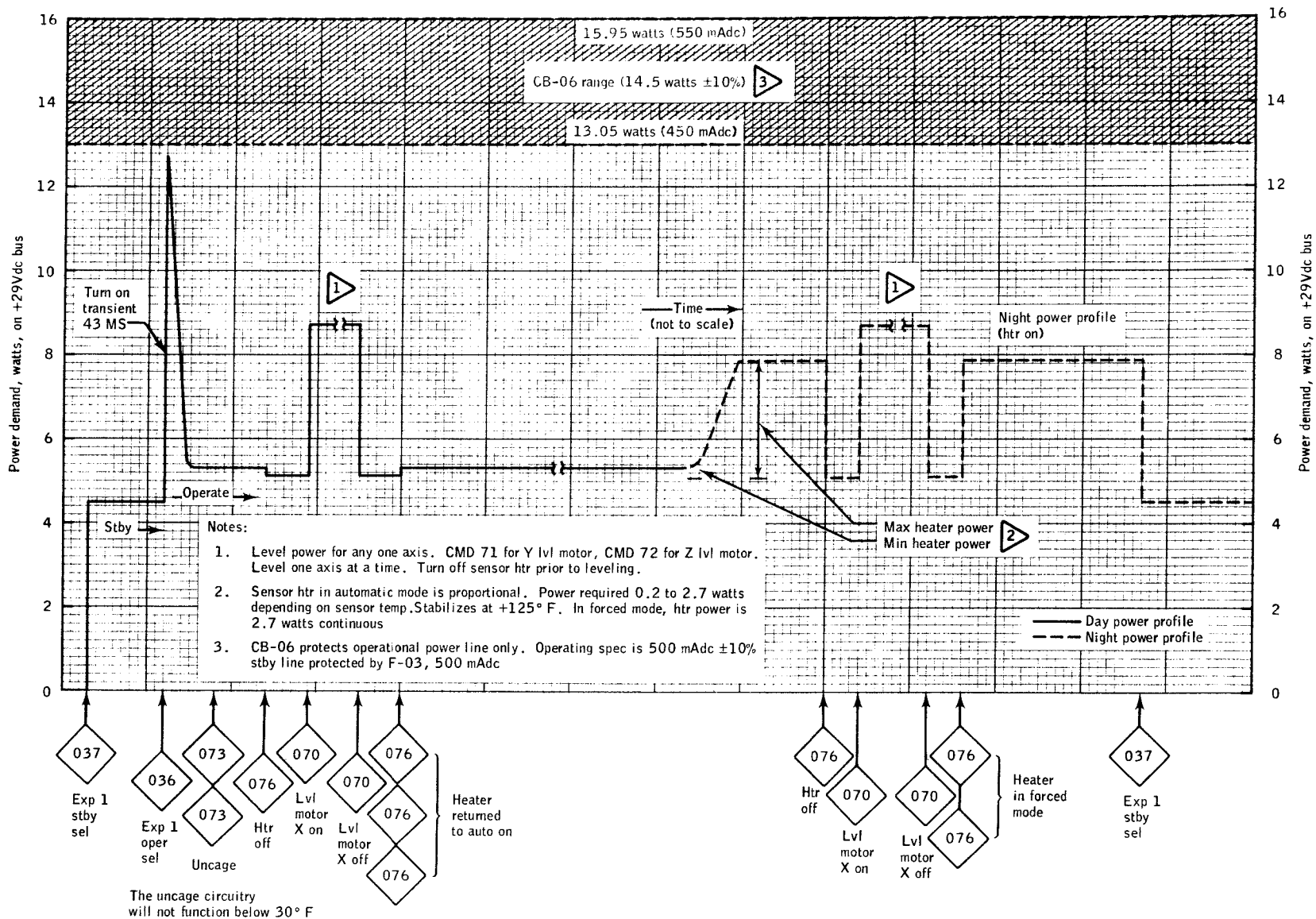
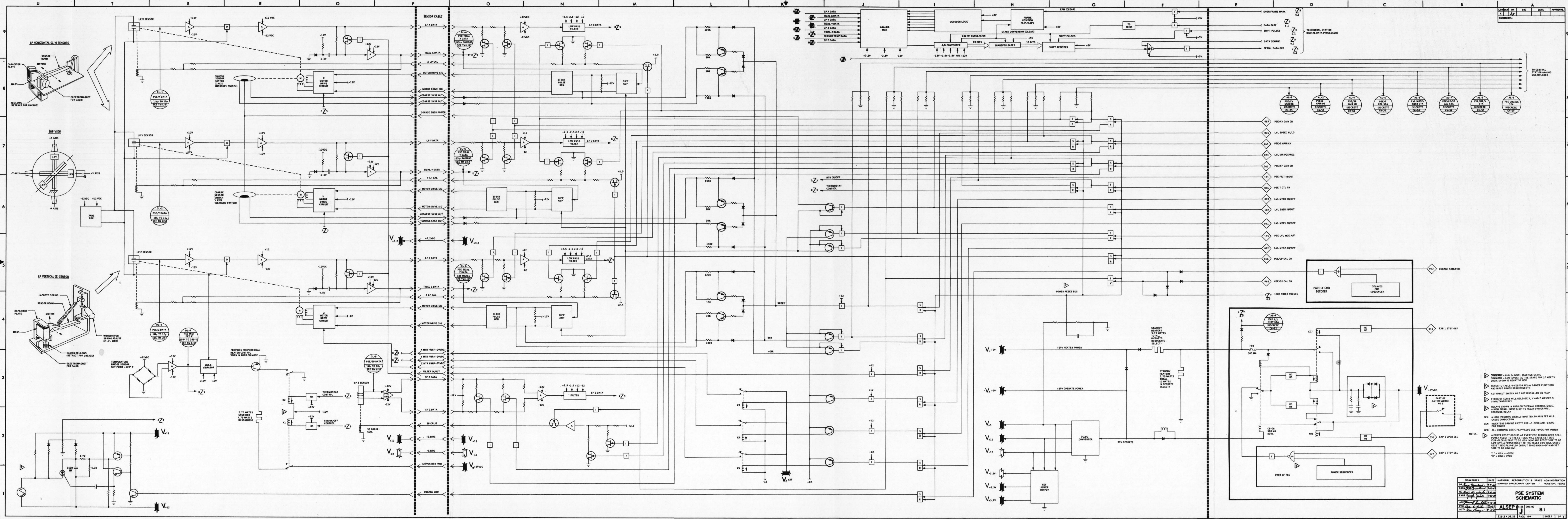

Figure 8-1.- PSE power profile.



REV	DATE	APPROVAL
1		

SIGNATURES	DATE	NATIONAL AERONAUTICS & SPACE ADMINISTRATION
DESIGNED: <i>[Signature]</i> CHECKED: <i>[Signature]</i> ENGINEER: <i>[Signature]</i> AUTH: <i>[Signature]</i>	15 SEP 68 115.5 M 21	MARSHALL SPACEFLIGHT CENTER - HOUSTON, TEXAS PSE SYSTEM SCHEMATIC 8.1

- NOTES:**
- COMMAND - HIGH (LOW) INACTIVE STATE
 - COMMAND - LOW (HIGH) ACTIVE STATE FOR 30 SECONDS
 - REFER TO TABLE 4-VIS FOR RELAY DRIVER FUNCTIONS AND INPUT POWER REQUIREMENTS
 - ASTRONAUT SWITCH NO. 4 NOT INSTALLED ON PSEP
 - POWERUP SIGNALS WILL RELEASE X, Y AND Z MASSES SIMULTANEOUSLY
 - RELAYS SHOWN IN AUTO ON TERMINAL CONTROL MODE, A HIGH SIGNAL INPUT TO RELAY DRIVER WILL ENERGIZE RELAY
 - A HIGH POSITIVE SIGNAL INPUT TO AN N-FET WILL CAUSE CONDUCTION
 - UNDETERMINED SIGNALS USE -1.2VDC AND -1.2VDC FOR POWER
 - ALL COMMAND LOGIC FLIP-FLOPS USE +5VDC FOR POWER
 - A POWER RESET OCCURS AT EVERY PSE TURN OVER SELL, POWER RESET TO THE SET SIDE WILL CAUSE SET SIDE FLIP-FLOP TO SET TO HIGH AND RESET TO GO TO LOW (LOW). A POWER RESET TO THE RESET SIDE WILL CAUSE RESET SIDE FLIP-FLOP TO SET TO HIGH AND RESET TO GO TO LOW (LOW).
 - "H" = HIGH = +5VDC
 - "L" = LOW = 0VDC

LSM
EXPERIMENT

LUNAR SURFACE MAGNETOMETER EXPERIMENT (SO 34)

9.1 SYSTEM DESCRIPTION

The Lunar Surface Magnetometer (LSM) Experiment provides data pertaining to the magnitude and temporal variations of the lunar surface equatorial magnetic field vector. The LSM does this by monitoring both the dc level and time variations of the magnetic field.

Physically, the LSM consists of three magnetic sensors, each mounted in a sensor head located at the end of three mutually perpendicular axes. The sensor electronics assembly converts the incident magnetic field intensity along the axes of the respective flux gate sensors into analog voltages. The axes extend equal distances above a central structure, the Electronics/Gimbal-Flip Unit (EGFU), which houses both the experiment electronics and the gimbal-flip unit. The experiment electronics are further subdivided into three functional categories: scientific data processing, engineering and status data processing, and output data buffer (see Drawing 9.3). The gimbal-flip unit houses the flipper drive motors which provide the motive power for 90 and 180-degree rotation (flipping) of the sensors and the release mechanism for the spring-driven 90-degree rotation (gimbaling) of the sensor axes. Instrument support and stability is achieved via three lunar support legs attached to the EFGU. When the LSM is deployed by the crew, it must be leveled to within ± 3 degrees. No command capability exists in the LSM for leveling.

The temperature of the magnetic sensors is monitored and provided as data output. The LSM heaters actuation temperature is 35°C (95°F).

TABLE 9-I.- PRESET CONDITIONS

"Preset" is defined as the initialized logic condition due to activation of the LSM experiment.

Command	Function	Presets To	Lunar Deployment Condition
043	EXP 2 STBY SEL		EXP IN STBY
123	LSM RANGE STEPS	+400 GAMMA	
124	LSM FLD O/S CH	0 PERCENT	
125	LSM O/S ADD CH	NEUTRAL	
127	FLIP/CAL INHIB	INHIBIT	
131	FLIP/CAL GO	NO-GO	
132	LSM FILT IN/OUT	IN	
133	SITE SURVEY XYZ	NO-GO	
134	LSM T CTL XYO	X	

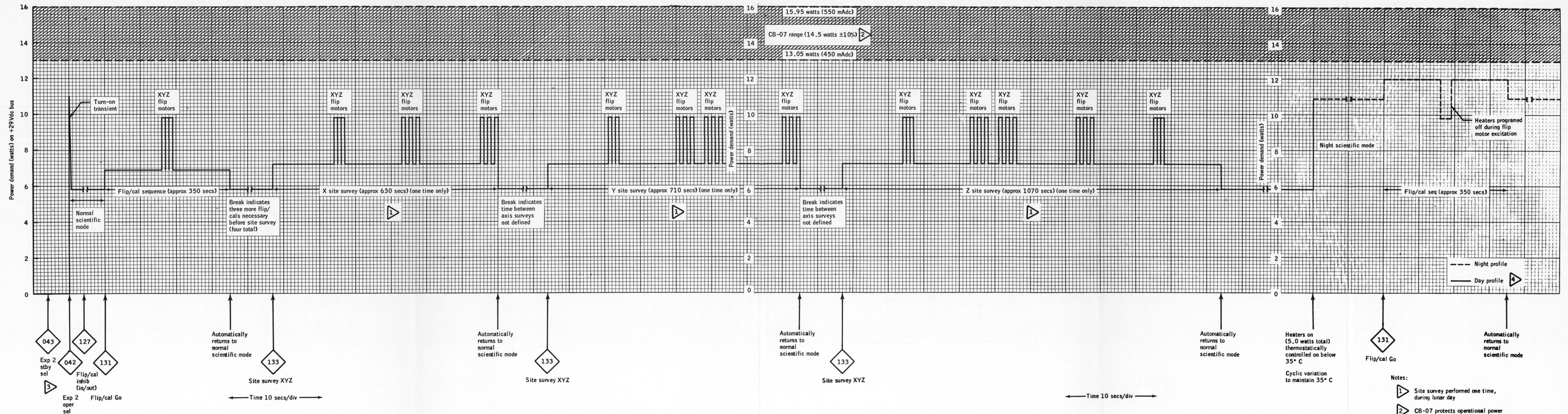

Figure 9-1.- LSM power profile.

- Notes:
- 1 Site survey performed one time, during lunar day
 - 2 CB-07 protects operational power line. Operating spec is 500 mA \pm 10%.
 - 3 LSM has no standby power demand
 - 4 Temperature assumed to be above +35° C. If below, add 5 watts for heater power. Heaters automatically programmed off during flip motor on time

*
9.1 FLIP CALIBRATION SEQUENCE (See Drawing 9.1)

The purpose of the flip cal sequence is to prevent permanent magnetization of the sensors due to lunar magnetic fields. The flip cal sequence further inserts calibration rasters of known levels to provide baseline data with which to compare lunar magnetic fields.

The flip cal sequence can be initiated by Ground Command 131 (FLIP/CAL GO), or by an automatically generated command via the ALSEP timer at 108 hours 1 minute and every 12 hours thereafter.

The flip cal sequence can be inhibited by means of Ground Command 127 (FLIP/CAL INHIB), which prevents the initiation of the flip cal sequence from either ground command or ALSEP timer generated command.

The sequence, once initiated, is completely controlled by the LSM flip cal programer and cannot be terminated by ground command. The sequence is completed in approximately 350 seconds.

The programer causes all necessary events to occur in the following order:

Upon receipt of the flip cal command, two calibration rasters are applied to all sensors (X, Y, and Z) simultaneously for 160 seconds. (Refer to Drawing 9.1.) The programer then flips all sensors sequentially 180 degrees and applies reverse field offset bias to each sensor. Upon completion of the flip action of the three sensors (30 seconds total, 10 seconds per sensor), the programer applies two more calibration rasters to all three sensors simultaneously for 160 seconds. Following the last calibration raster, the programer stops the flip cal sequence generator, at which time the LSM is in the normal scientific mode. The result of the flip cal sequence is that the sensors are now oriented diametrically opposite in direction, with field offset bias of opposite polarity to that prior to the initiation of the flip cal sequence.

GAMMA RANGE	SENSOR POSITION	% OFFSET						
		0	+25	+50	+75	-75	-50	-25
100	0° OR 90°	+100	+125	+150	+175	+25	+50	+75
	180°	-100	-75	-50	-25	-175	-150	-125
200	0° OR 90°	+200	+250	+300	+350	+50	+100	+150
	180°	-200	-250	-300	-350	-50	-100	-150
400	0° OR 90°	+400	+500	+600	+700	+100	+200	+300
	180°	-400	-500	-600	-700	-100	-200	-300

LSM EFFECTIVE RANGES AS A FUNCTION OF OFFSET AND SENSOR POSITION

SENSOR POSITION			
DM-9	DM-10	DM-11	Z
01 (0°)	✓	✓	✓
10 (90°)	✓	✓	✓
00 (FAIL)			

SENSOR POSITION			
DM-9	DM-10	DM-11	Z
01 (0°)	✓	✓	✓
10 (90°)	✓	✓	✓
11 (180°)	✓	✓	✓
00 (FAIL)			

SENSOR POSITION			
DM-9	DM-10	DM-11	Z
01 (0°)	✓	✓	✓
10 (90°)	✓	✓	✓
11 (180°)	✓	✓	✓
00 (FAIL)			

SENSOR POSITION			
DM-9	DM-10	DM-11	Z
01 (0°)	✓	✓	✓
10 (90°)	✓	✓	✓
11 (180°)	✓	✓	✓
00 (FAIL)			

SENSOR POSITION			
DM-9	DM-10	DM-11	Z
01 (0°)	✓	✓	✓
10 (90°)	✓	✓	✓
11 (180°)	✓	✓	✓
00 (FAIL)			

SCIENTIFIC ORIENTATION AFTER FLIP CAL SEQ NO 1 (180 DEGREES)

SENSOR POSITION			
DM-9	DM-10	DM-11	Z
01 (0°)	✓	✓	✓
10 (90°)	✓	✓	✓
11 (180°)	✓	✓	✓
00 (FAIL)			

SCIENTIFIC ORIENTATION AFTER FLIP CAL SEQ NO 2 (0 DEGREES)

SENSOR POSITION			
DM-9	DM-10	DM-11	Z
01 (0°)	✓	✓	✓
10 (90°)	✓	✓	✓
11 (180°)	✓	✓	✓
00 (FAIL)			

SCIENTIFIC ORIENTATION AFTER FLIP CAL SEQ NO 3 (180 DEGREES)

SENSOR POSITION			
DM-9	DM-10	DM-11	Z
01 (0°)	✓	✓	✓
10 (90°)	✓	✓	✓
11 (180°)	✓	✓	✓
00 (FAIL)			

SCIENTIFIC ORIENTATION AFTER FLIP CAL SEQ NO 4 (0 DEGREES)

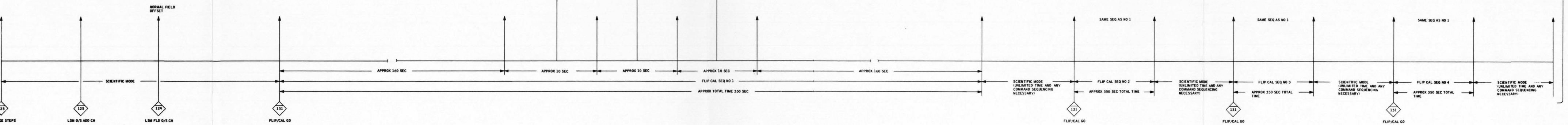
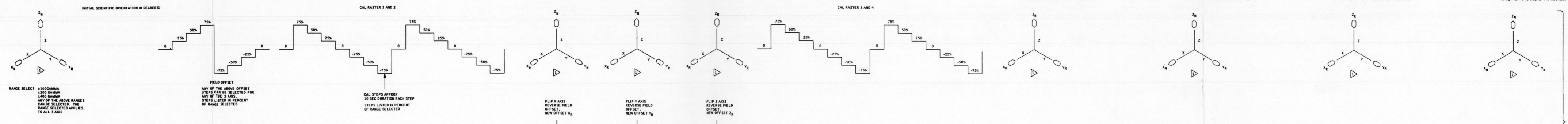

RANGE SELECT: 1100GAMMA
1200 GAMMA
1400 GAMMA
ANY OF THE ABOVE RANGES CAN BE SELECTED. THE RANGE SELECTED APPLIES TO ALL 3 AXES

FIELD OFFSET
ANY OF THE ABOVE OFFSET STEPS CAN BE SELECTED FOR ANY OF THE 3 AXES. STEPS LISTED IN PERCENT OF RANGE SELECTED

CAL STEPS APPROX 10 SEC DURATION EACH STEP
STEPS LISTED IN PERCENT OF RANGE SELECTED

FLIP X AXIS
REVERSE FIELD OFFSET
NEW OFFSET X_r

FLIP Y AXIS
REVERSE FIELD OFFSET
NEW OFFSET Y_r

FLIP Z AXIS
REVERSE FIELD OFFSET
NEW OFFSET Z_r

READY FOR 3-AXIS SITE SURVEY

NOTE:
 X_r = X AXIS FIELD OFFSET NORMAL
 X_r = X AXIS FIELD OFFSET REVERSED
 Y_r = Y AXIS FIELD OFFSET NORMAL
 Y_r = Y AXIS FIELD OFFSET REVERSED
 Z_r = Z AXIS FIELD OFFSET NORMAL
 Z_r = Z AXIS FIELD OFFSET REVERSED

*
9.3 SITE SURVEY SEQUENCE (Refer to Drawing 9.2)

The site survey sequence is performed upon completion of the first four flip cal sequences and will be performed only once during the life of the instrument. The purpose of the site survey sequence is to measure local accretions of nickel-iron or stony-iron meteoric debris.

9.3.1 X-axis Site Survey Sequence

Initiation of Ground Command 133 (Site Survey XYZ) simultaneously applies power to the site survey programmer and to the flip cal programmer. Once the sequence is initiated, it cannot be terminated by ground command. The site survey is completed in approximately 630 seconds.

Upon receipt of the site survey command, the programmer is sequenced to an idle state. The programmer then sequences the sensors through a normal flip cal sequence. Upon completion of the flip cal sequence, the programmer flips all sensors sequentially so that they are surveying the X-axis and applies the X field offset bias to each sensor. On completion of the flip action, the programmer places the instrument into X site survey state. Upon completion of site survey, the programmer sequentially flips all sensors back to the previous position and reverses and reinstates the previous field offset bias to each sensor.

9.3.2 Y-axis Site Survey Sequence

Upon initiation by Ground Command 133, power is simultaneously applied to both the site survey and flip cal programmers. Site survey cannot be terminated by ground command and completes its sequence in approximately 710 seconds.

On receipt of the command, the programmer is sequenced to an idle state. The programmer then sequences the sensors through a normal flip cal sequence, with one exception: during the flip cal sequence the Y- and Z-axis sensor assemblies are gimballed (90-degree longitudinal rotation). Upon completion of the flip cal sequence, the programmer flips all sensors sequentially 180 degrees and applies reverse field offset bias to each sensor. After completion of the 180-degree flip action, the programmer flips all sensors sequentially so that they are surveying the Y-axis and applies the Y field offset bias to each sensor. On completion of the flip action, the programmer places the instrument into Y site survey state. Upon completion of site survey, the programmer sequentially flips all sensors back to the previous position and reverses and reinstates the previous field offset bias to each sensor.

9.3.3 Z-axis Site Survey Sequence

Initiation by Ground Command 133 is identical to the previous site survey initiations. The Z-axis site survey completes its sequence in 1070 seconds. Upon receipt of the site survey command, the programmer is sequenced to an idle state. The programmer then sequences the sensors through a normal flip cal sequence, with one exception: during the flip cal sequence the X-axis sensor assembly is gimballed (90-degree longitudinal rotation). Upon completion of the flip cal sequence, the programmer flips all sensors sequentially 180 degrees and applies reverse field offset bias to each sensor. On completion of the 180-degree flip action, the programmer again flips all sensors sequentially so that they are surveying the Z-axis and applies the Z field offset bias to each sensor. On completion of the flip action, the programmer places the instrument into Z site survey state. Upon completion of site survey, the programmer sequentially flips all sensors back to the previous position and reverses and reinstates the previous field offset bias to each axis. On completion of sensor reinstatement two calibration rasters are applied to all sensors simultaneously. The programmer then flips all sensors sequentially 180 degrees and applies reverse field offset bias to each sensor. The programmer then flips all sensors (X, Y, and Z) simultaneously 180 degrees and applies simultaneously reverse field offset bias to each sensor. Upon completion of the flip action of the three sensors, the programmer applies two more calibration rasters to all three sensors simultaneously. Following the last calibration raster, the programmer stops the site survey sequence, at which time the LSM is in the normal scientific mode.

X-AXIS SITE SURVEY

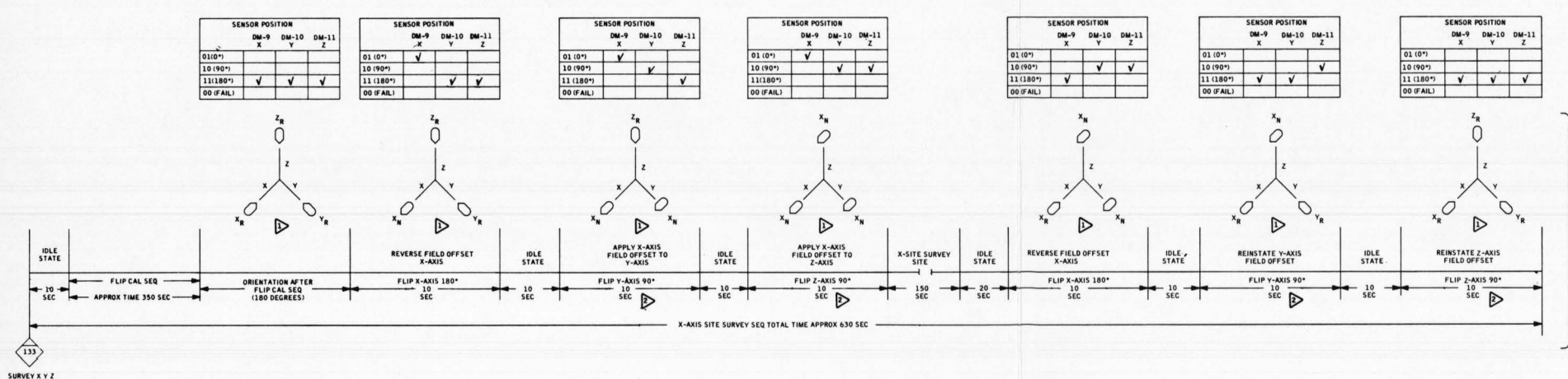

Y-AXIS SITE SURVEY

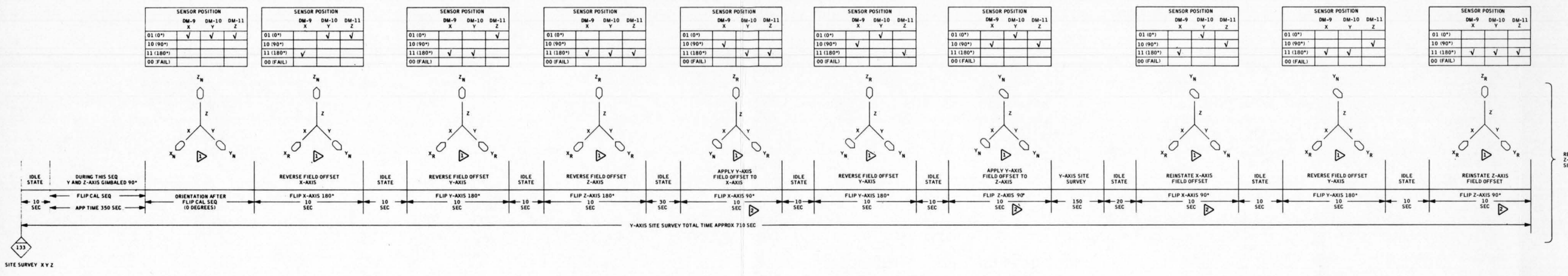

Z-AXIS SITE SURVEY

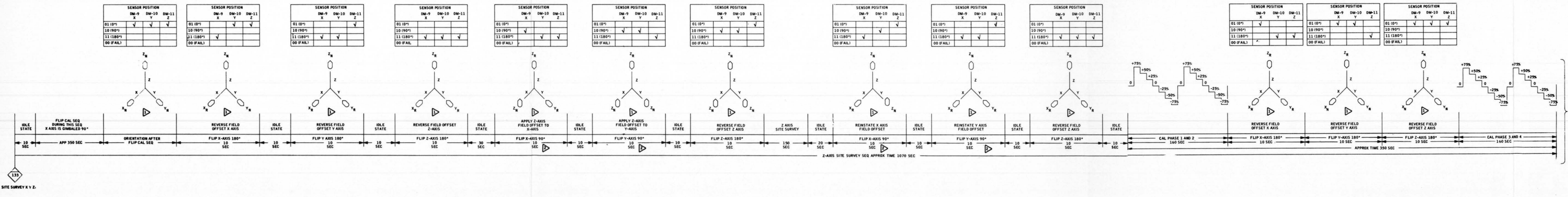

RANGE	SENSOR POSN	PERCENT OFFSET					
		0	+25	+50	+75	-50	-25
100	0° DR 90°	+100	+125	+150	+175	+25	+75
	180°	+100	+75	+50	+25	+150	+125
200	0° DR 90°	+200	+250	+300	+350	+50	+150
	180°	+200	+150	+100	+50	+350	+300
400	0° DR 90°	+400	+500	+600	+700	+100	+300
	180°	+400	+300	+200	+100	+700	+500

LSM EFFECTIVE RANGES AS A FUNCTION OF OFFSET AND SENSOR POSITION

ALTHOUGH THE DRAWING SHOWS A 45° FLIP, THE ACTUAL HARDWARE FLIPS 90° TO ACQUIRE THIS POSITION

X₀ = X-AXIS FIELD OFFSET NORMAL
 X₁ = X-AXIS FIELD OFFSET REVERSED
 Y₀ = Y-AXIS FIELD OFFSET NORMAL
 Y₁ = Y-AXIS FIELD OFFSET REVERSED
 Z₀ = Z-AXIS FIELD OFFSET NORMAL
 Z₁ = Z-AXIS FIELD OFFSET REVERSED

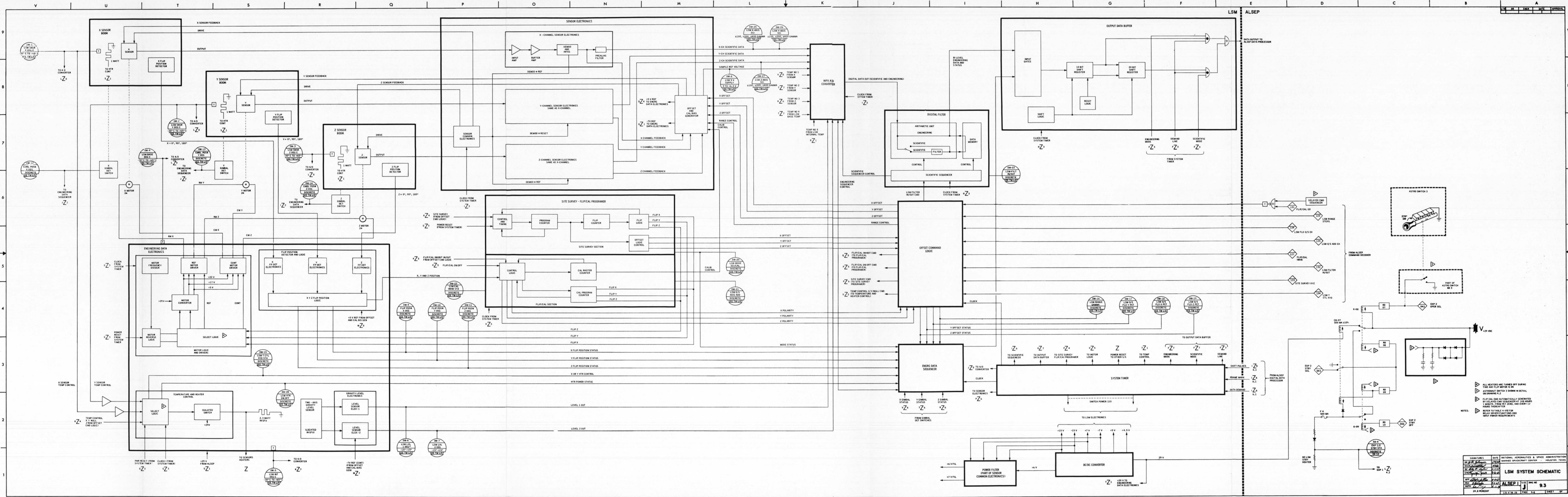

SIGNATURES		DATE		NATIONAL AERONAUTICS & SPACE ADMINISTRATION	
SM-1	SM-2	1/7/70	1/7/70	MANNED SPACECRAFT CENTER - HOUSTON, TEXAS	
SM-3	SM-4	1/7/70	1/7/70		
SM-5	SM-6	1/7/70	1/7/70		
SM-7	SM-8	1/7/70	1/7/70		
SM-9	SM-10	1/7/70	1/7/70		
SM-11	SM-12	1/7/70	1/7/70		
SM-13	SM-14	1/7/70	1/7/70		
SM-15	SM-16	1/7/70	1/7/70		
SM-17	SM-18	1/7/70	1/7/70		
SM-19	SM-20	1/7/70	1/7/70		
SM-21	SM-22	1/7/70	1/7/70		
SM-23	SM-24	1/7/70	1/7/70		
SM-25	SM-26	1/7/70	1/7/70		
SM-27	SM-28	1/7/70	1/7/70		
SM-29	SM-30	1/7/70	1/7/70		
SM-31	SM-32	1/7/70	1/7/70		
SM-33	SM-34	1/7/70	1/7/70		
SM-35	SM-36	1/7/70	1/7/70		
SM-37	SM-38	1/7/70	1/7/70		
SM-39	SM-40	1/7/70	1/7/70		
SM-41	SM-42	1/7/70	1/7/70		
SM-43	SM-44	1/7/70	1/7/70		
SM-45	SM-46	1/7/70	1/7/70		
SM-47	SM-48	1/7/70	1/7/70		
SM-49	SM-50	1/7/70	1/7/70		
SM-51	SM-52	1/7/70	1/7/70		
SM-53	SM-54	1/7/70	1/7/70		
SM-55	SM-56	1/7/70	1/7/70		
SM-57	SM-58	1/7/70	1/7/70		
SM-59	SM-60	1/7/70	1/7/70		
SM-61	SM-62	1/7/70	1/7/70		
SM-63	SM-64	1/7/70	1/7/70		
SM-65	SM-66	1/7/70	1/7/70		
SM-67	SM-68	1/7/70	1/7/70		
SM-69	SM-70	1/7/70	1/7/70		
SM-71	SM-72	1/7/70	1/7/70		
SM-73	SM-74	1/7/70	1/7/70		
SM-75	SM-76	1/7/70	1/7/70		
SM-77	SM-78	1/7/70	1/7/70		
SM-79	SM-80	1/7/70	1/7/70		
SM-81	SM-82	1/7/70	1/7/70		
SM-83	SM-84	1/7/70	1/7/70		
SM-85	SM-86	1/7/70	1/7/70		
SM-87	SM-88	1/7/70	1/7/70		
SM-89	SM-90	1/7/70	1/7/70		
SM-91	SM-92	1/7/70	1/7/70		
SM-93	SM-94	1/7/70	1/7/70		
SM-95	SM-96	1/7/70	1/7/70		
SM-97	SM-98	1/7/70	1/7/70		
SM-99	SM-100	1/7/70	1/7/70		

LSM SYSTEM SCHEMATIC

10 SWS
EXPERIMENT

SOLAR WIND SPECTROMETER EXPERIMENT (SO 35)

10.1 SYSTEM DESCRIPTION

The Solar Wind Spectrometer (SWS) Experiment provides data pertaining to certain properties of the solar wind plasma as it exists at the lunar surface. It measures temporal and directional variations in the flux and energy of positive ions and electrons that strike the lunar surface.

The basic sensor in the SWS is a Faraday cup which measures the charged particle flux by collecting these ions and using a very sensitive current amplifier to determine the resulting current flow. The SWS contains seven of these cups arranged in a uniformly geometric fashion that allows flux measurements to be taken above the horizon. This also allows measurement of the angular distribution of the ion flux. One cup is oriented to face vertically, and the remaining six cups are arranged around this vertical cup such that the normals between any two adjacent cups are at an angle of approximately one radian.

The operation of the SWS in measuring the charged particles of the solar wind may be classified into five functional activities. These functions are sequencing, sensor excitation, measurement, data handling, and power supply.

The sequencing function controls internal data handling and processing and generates the internal commands for sequencing various data, calibration, and housekeeping inputs. The sequencing function controls:

- A. The preamplifier switch that connects any one, or all, of the preamplifiers to the input of the current measurement chain.
- B. The voltage applied by the sensor excitation function to the modulator grids of the sensors to select the proper polarity and energy band of particles to be measured.
- C. Solid-state switches so that the gain of the current measuring chain, the magnitude of critical voltages, temperatures, and calibration data for the analog-to-digital converter can be read into the telemetry to check circuit operation and changes in calibration.

The sensor excitation function is a high-voltage generator which produces a set of discrete dc voltage outputs between approximately -1000 and +8000 V and a set of discrete square wave ac voltages with half amplitudes between approximately 5 and 1400 V. Under the control of the sequencing function, it applies combinations of these voltages to the sensor-cup modulator grid in such a way as to cover the expected solar wind energy regions for protons and electrons. Two distinct sets of voltages can be selected by a ground command which changes the amplifier's gain by the factor 1.68.

The measurement function includes the particle sensors, temperature sensors, sun sensor, and signal chain.

The signal chain is a series of electronic circuits which amplifies and demodulates the currents from the seven sensor collectors. Under control of the sequencing function, it selects the collector current to be measured or linearly sums all seven currents.

The data handling function accepts analog measurement data, performs analog-to-digital conversion, and provides the data to the ALSEP DSS upon demand.

The power supply converts the ALSEP bus power of 29 V regulated dc into the appropriate dc voltages needed for the SWS. It includes a dc-to-ac inverter, rectifier, control circuits and transformer. It provides dc isolation for the SWS from the ALSEP power lines.

The SWS operational heater actuation temperature is 20°C (68°F).

The SWS is initialized in the low gain mode. To place the instrument in the high gain mode, transmit Cmd 122 (SWS CVR GO) three times within 10 seconds. This causes the electron and proton measurement voltage levels to increase by a factor of 1.68 over the low gain mode.

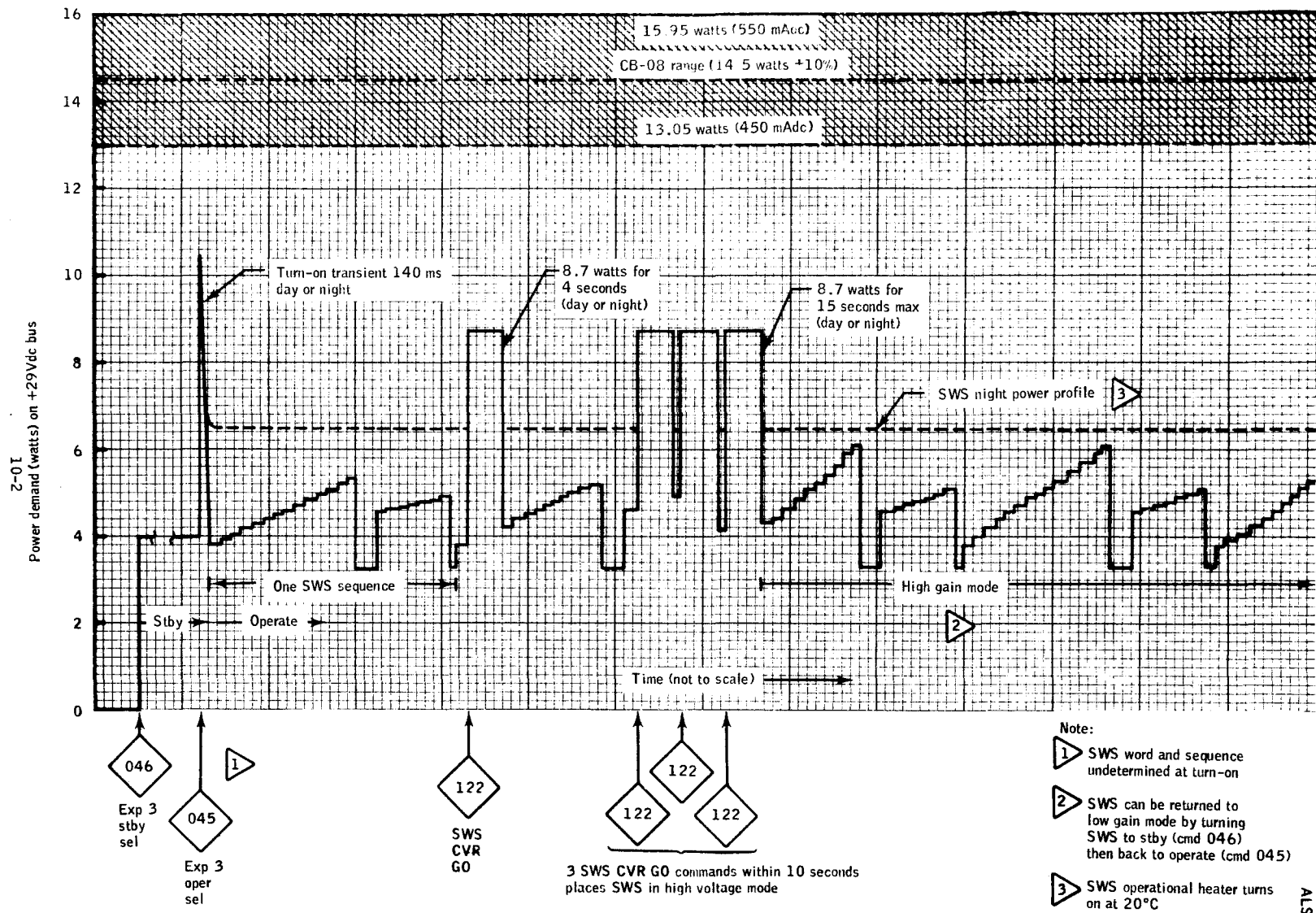

Figure 10-1. - SWS power profile.

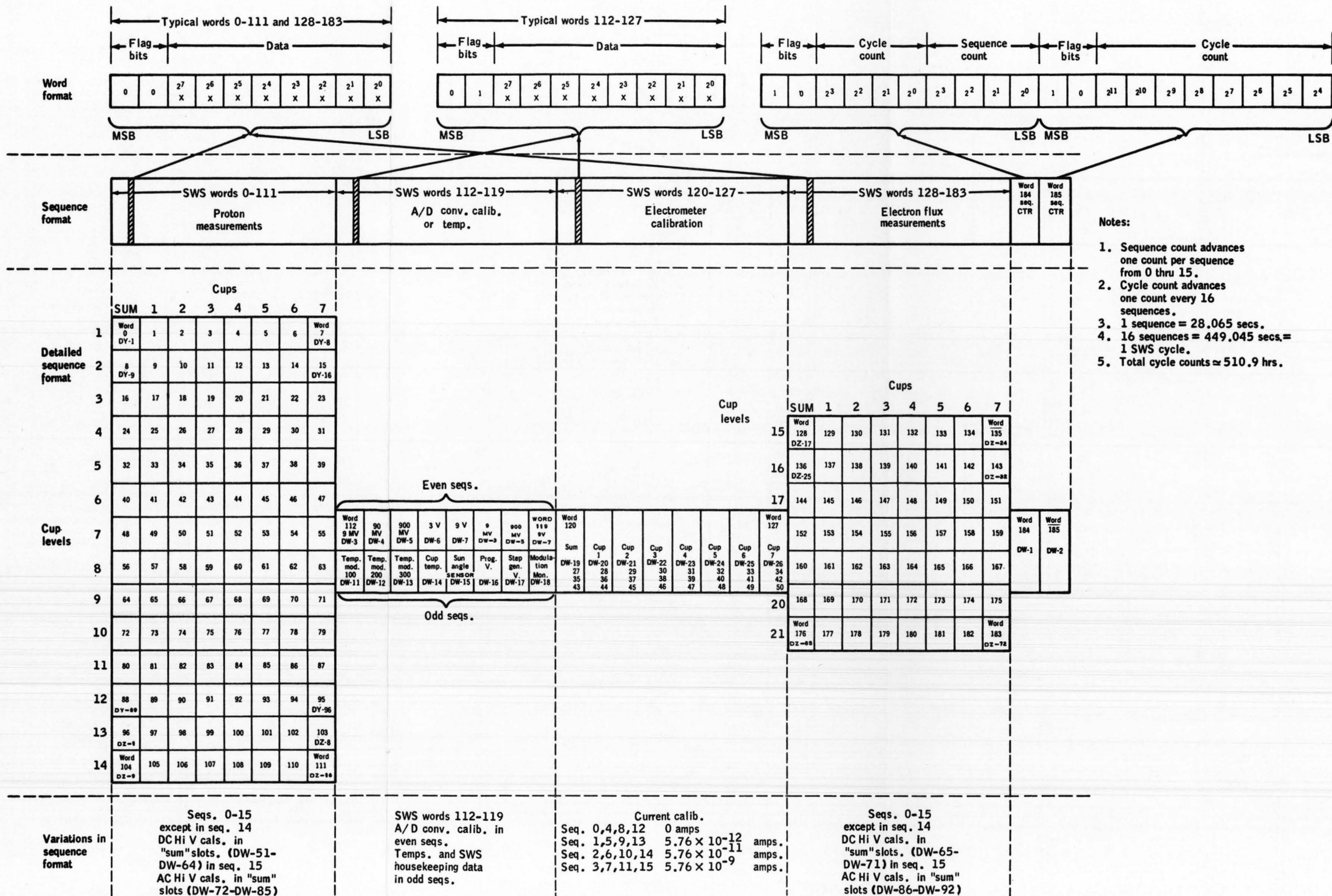
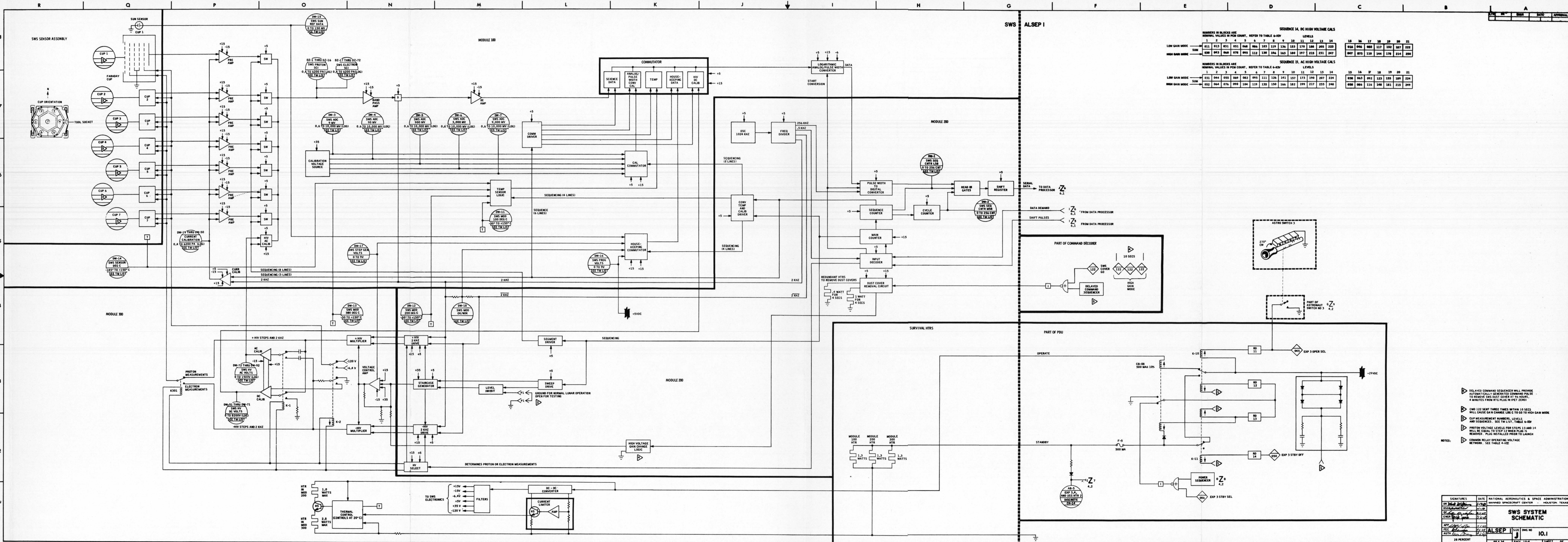

TABLE 10-I. - SWS TELEMETRY FORMAT



SEQUENCE 14, DC HIGH VOLTAGE CALS

NUMBERS IN BLOCKS ARE NOMINAL VALUES IN POS COUNT, REFER TO TABLE 6-20V LEVELS	1	2	3	4	5	6	7	8	9	10	11	12	13	14	15	16	17	18	19	20	21
LOW GAIN MODE	011	013	031	051	066	066	103	119	136	153	170	188	205	223	036	046	082	117	152	187	222
HIGH GAIN MODE	030	043	060	078	093	112	130	146	163	180	197	215	231	247	047	075	110	144	178	214	250

SEQUENCE 15, AC HIGH VOLTAGE CALS

NUMBERS IN BLOCKS ARE NOMINAL VALUES IN POS COUNT, REFER TO TABLE 6-20V LEVELS	1	2	3	4	5	6	7	8	9	10	11	12	13	14	15	16	17	18	19	20	21
LOW GAIN MODE	031	044	055	069	082	095	111	126	141	157	173	190	207	224	030	043	092	123	155	189	224
HIGH GAIN MODE	052	064	076	090	104	119	135	150	166	182	199	217	233	248	030	046	116	148	181	215	248

- NOTES:
- ▷ DELAYED COMMAND SEQUENCE WILL PROVIDE AUTOMATICALLY GENERATED COMMAND PULSE TO REMOVE SWS DUST COVER AT 90 HOURS, 4 MINUTES FROM RFL PLUG IN (PFT 2601)
 - ▷ CMD 122 SENT THREE TIMES WITHIN 10 SECS WILL CAUSE GAIN CHANGE LOGIC TO GO TO HIGH GAIN MODE
 - ▷ CUP MEASUREMENT NUMBERS, LEVELS AND SEQUENCES - SEE TM LIST, TABLE 6-20V
 - ▷ PROTON VOLTAGE LEVELS FOR STEPS 13 AND 14 WILL BE EQUAL TO STEP 12 WHEN PLUG IS REMOVED. PLUG INSTALLED PRIOR TO LAUNCH
 - ▷ COMMON RELAY OPERATING VOLTAGE NETWORK - SEE TABLE 4-10E

11 SIDE/CCGE
EXPERIMENT

SUPRATHERMAL ION DETECTOR EXPERIMENT/COLD
CATHODE GAGE EXPERIMENT (SO 36)

11.1 SYSTEM DESCRIPTION

The Suprathermal Ion Detector Experiment (SIDE) will provide data pertaining to the density and the temperature of the lunar ionosphere as it exists near the lunar surface. SIDE measurements include ion counts as well as measurement of the velocity and the energy associated with the detected particles. The Cold Cathode Gage Experiment (CCGE) will determine the neutral particle density at the lunar surface and any variations in that density associated with solar activity. Specifically, the CCGE will measure the density and temperature of the lunar environment, from which pressure is derived.

The low-energy particle sensor used in the SIDE has a velocity filter composed of crossed electric and magnetic fields followed by a low-energy curved plate analyzer. The velocity filter passes ions with proper velocities, and the low-energy curved plate analyzer passes ions with the proper energy. The particles that pass through the curved plate analyzer are detected and counted. The velocity filter selects ions with velocities ranging from 4×10^4 to 9.35×10^6 cm/sec. The low-energy curved plate analyzer covers an energy range of 0.2 to 48.6 eV per unit charge. The instrument also contains a high-energy curved plate analyzer without a velocity filter that detects and counts solar wind particles in the range from 10 to 3500 eV per unit charge.

In order to overcome electric fields that may be present at the lunar surface, the instrument rests on a ground plane. This ground plane consists of a wire mesh which is spread out on the lunar surface by the crewman. A power supply in the instrument applies voltage between the instrument electronics and the ground plane to investigate and overcome any electric field effects.

The velocity filter, low-energy curved plate analyzer, high energy curved plate analyzer, and ground plane voltages are controlled in steps by the SIDE timing and SIDE frame counter circuits to allow measurements of particle velocity and energy within the given ranges. Relative values of these functions with respect to SIDE frame number are shown in Figures 11-2 through 11-5.

The CCGE consists of a Cold Cathode Ion Gage (CCIG) and its associated electronics. These are mounted in the same package as the Suprathermal Ion Detector Experiment during the flight to the moon. When the crewman deploys the package, he removes the CCIG and places it a few feet away from the SIDE. An electrical cable connects the CCIG to the SIDE. The ion gage produces an electrical current that is proportional to the measured pressure over the desired pressure range of 10^{-6} torr to 10^{-12} torr. This current is amplified and read out as the experiment scientific data.

Upon deployment by the crew, the SIDE is to be leveled within ± 5 degrees. No command capability exists in the SIDE to command leveling.

The SIDE heater actuation temperature is $0^\circ \pm 8^\circ\text{C}$ (32°F).

TABLE 11-I.- SIDE/CCGE PRESET CONDITIONS

Activation will cause the following functions to be preset:

- Velocity Filter Voltage to ON
- HECPA High Voltage to ON
- LECPA High Voltage to ON
- Channeltron High Voltage to ON
- CCIG High Voltage to ON
- Resets all Command Flip-Flops
- Resets SIDE Frame Counter
- Resets Velocity Filter Counter
- Resets HECPA Counter
- Resets LECPA Counter
- Resets Ground Plane Counter,
Step Programmer ON
- Causes Normal Mode (128 SIDE Frames cycle)
to be outputted, X10 Accumulation OFF

NOTE

"Preset" is defined as logic condition due to activation of sub-system.

TABLE 11-II.- GROUND PLANE STEPPER SEQUENCE

SIDE/CCGE Cycle Number	DI-63 Ground Plane Step Reading	DI-11 Ground Plane Voltage (volts)
0	0	0
1	1	+0.6
2	2	+1.2
3	3	+1.8
4	4	+2.4
5	5	+3.6
6	6	+5.4
7	7	+7.8
8	8	+10.2
9	9	+16.2
10	10	+19.8
11	11	+27.6
12	16	0
13	17	-0.6
14	18	-1.2
15	19	-1.8
16	20	-2.4
17	21	-3.6
18	22	-5.4
19	23	-7.8
20	24	-10.2
21	25	-16.2
22	26	-19.8
23	27	-27.6
0	0	0
↓		↓
23	27	-27.6

TABLE 11-III.- SIDE WORD TWO TELEMETRY

Telemetry Point VOLTAGES	SIDE Frame 0	Reset SIDE Frame Counter at 10	Reset SIDE Frame Counter at 39	Reset SIDE Frame Counter at 79
DI1 (+5 V ANALOG)	0	32	64	96
DI7 (+4.5 KV)	8		40,72	104
DI13 (+60 V)		16	48	80,112
DI14 (+30 V)		17	49	81,113
DI15 (+5 V DIGITAL)		18	50	82,114
DI16 (GND)		19	51	83,115
DI17 (-5 V)		20	52	84,116
DI18 (-30 V)		21	53	85,117
DI20 (-3.5 KV)		23	55	87,119
DI21 (+1 V CAL)		27	59	91
DI22 (+30 MV CAL)		25	57	89
DI23 (+A/D REF)		26	58	90
DI25 (-A/D REF)		30	62	94
DI26 (-1 V CAL)		37		101
DI27 (-12 V CAL)		39		103
DI28 (+12 V)		28	60	92
DI30 (-30 MV CAL)			46	110
<u>TEMPERATURES</u>				
DI4 (1-CCIG)	2	34	66	98
DI5 (2-200 BLIVET)	4	36	68	100
DI6 (3-500 BLIVET)	6	38	70	102
DI9 (4-100 BLIVET)		11	43,75	107
DI10 (5-300 BLIVET)		12	44,76	108
DI19 (6-800 BLIVET)		22	54	86,118
<u>DATA & MISC</u>				
DF29 (OTC REG)		33,35		97,99
DI3 (CCGE SCI)	1,3,5,7,9		41,73	105,121-127
DI6 (CCGE RNG)	10	24	42,56,74	88,106,110
DI11 (GND PLN VOLT)		13,15,29,31	45,47,61,63,69,77,79	93,95,109,111
DI12 (SOLAR CELL)		14	78	
DI24 (DST CVR/SEAL)			67,71	
DI29 (PRE REG D/F)			65	

NOTE

SIDE turn-on will initialize all command registers to their preset state. TM parameters DF-29 (SIDE O/T CMD LOAD), DI-24 (SIDE/A CVR/S STA), and DI-66 (SIDE/D CVR/S STA) will indicate PRESET. The first transmission of any command sequence containing commands 105 and 110, after turn-on, will cause DF-29, DI-24, and DI-66 to indicate that the seal has been broken. The first transmission of any command sequence containing commands 107 and 110, after turn-on, will cause DF-29, DI-24, DI-66 to indicate that the dust cover has been removed. Seal break circuit activation causes no additional power demand. However, the dust cover circuit activation will cause an increase in power demand of 6 watts. The SIDE operational heater power is interrupted during the dust cover circuit activation time (approximately 2.5 seconds) to prevent SIDE circuit breaker CB-09 from actuating. Further transmission of command sequences containing commands 105 and 107 will have no effect on the seal break circuit, dust cover removal circuit, or TM parameters DF-29, DI-24, and DI-66. (Refer to Figure 11-1.)

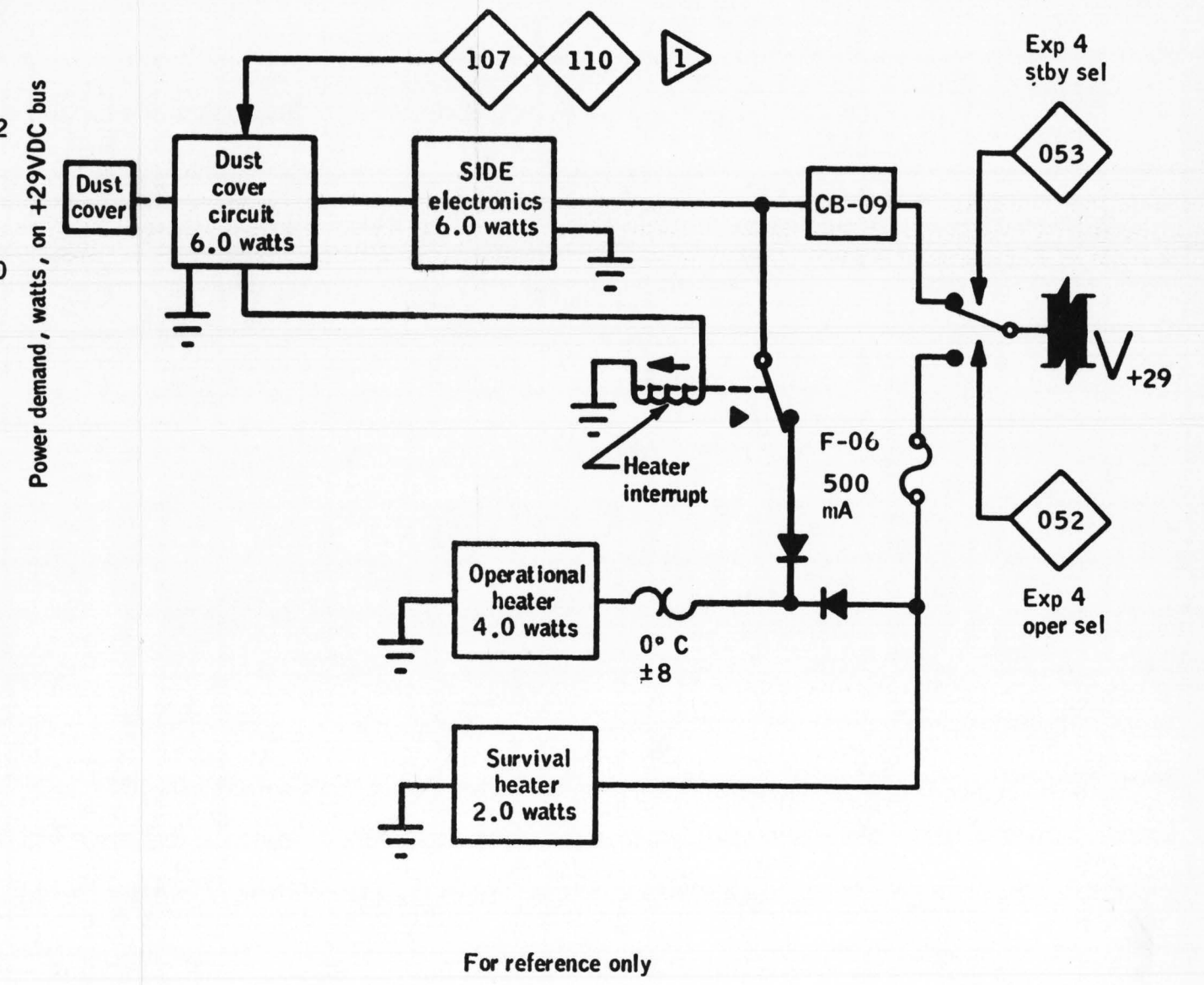
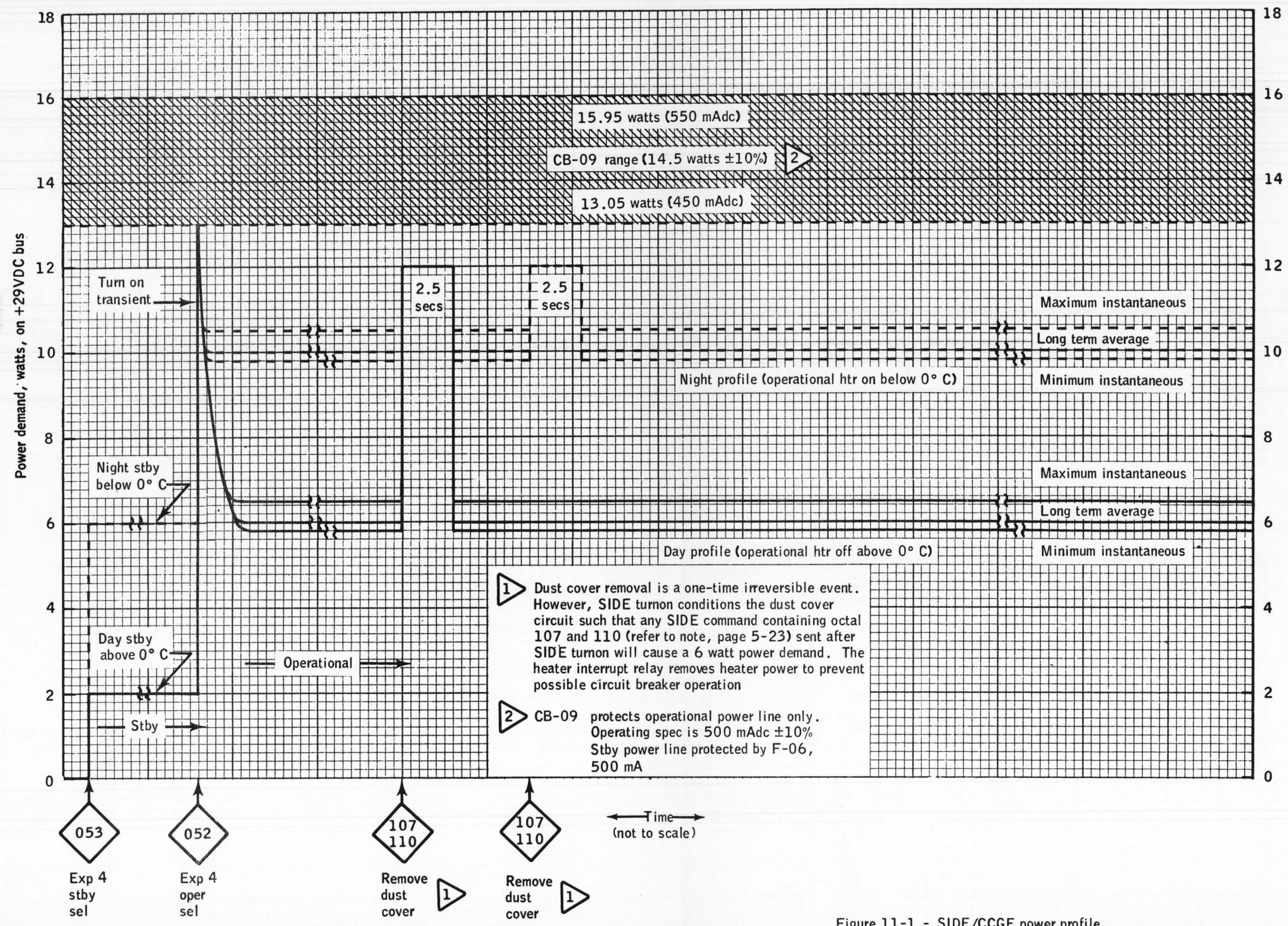
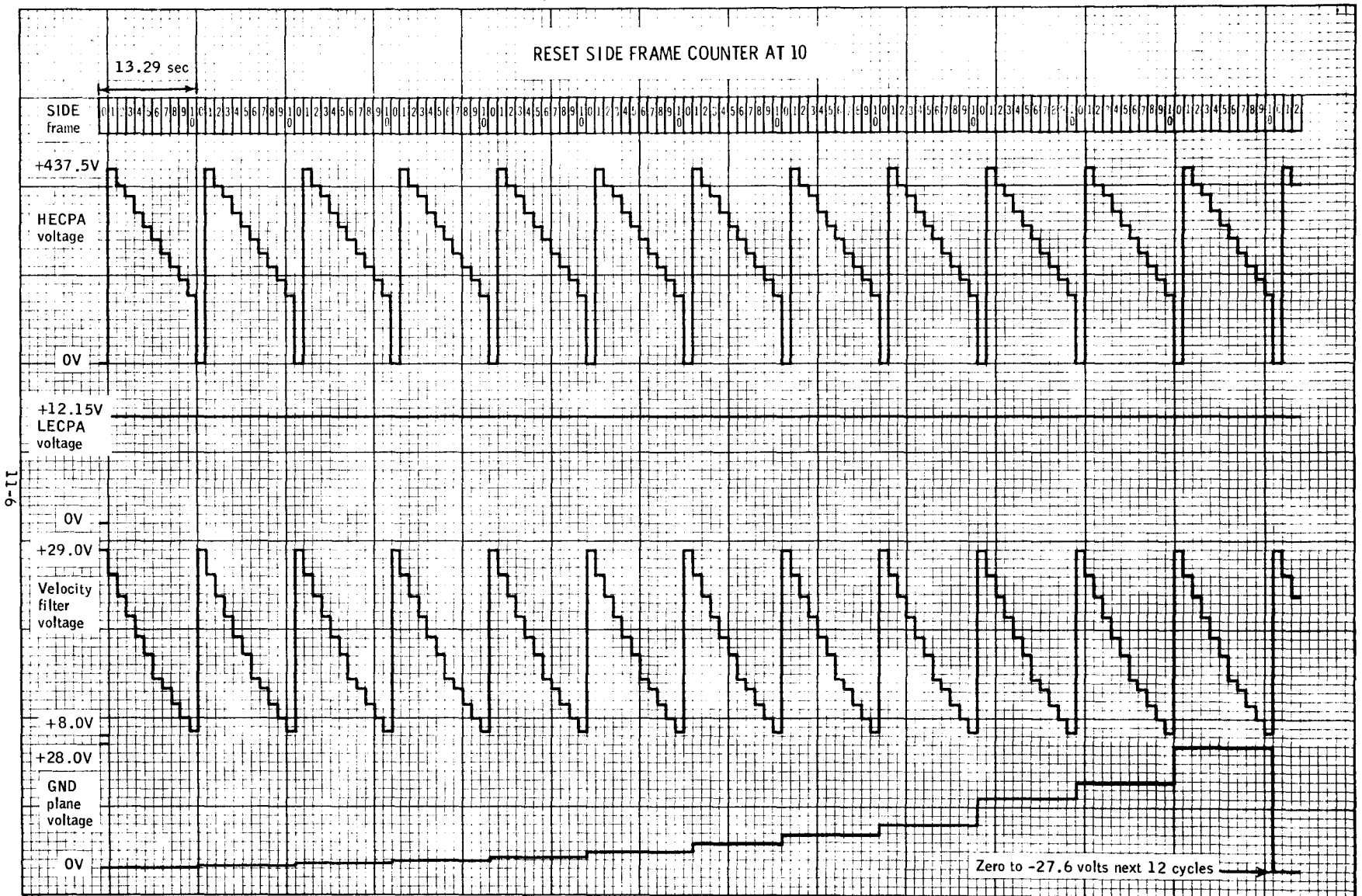

Figure 11-1.- SIDE/CCGE power profile.



11-6

Figure 11-3. - Programed sensor voltage variations (reset at 10).

ALSEP 1

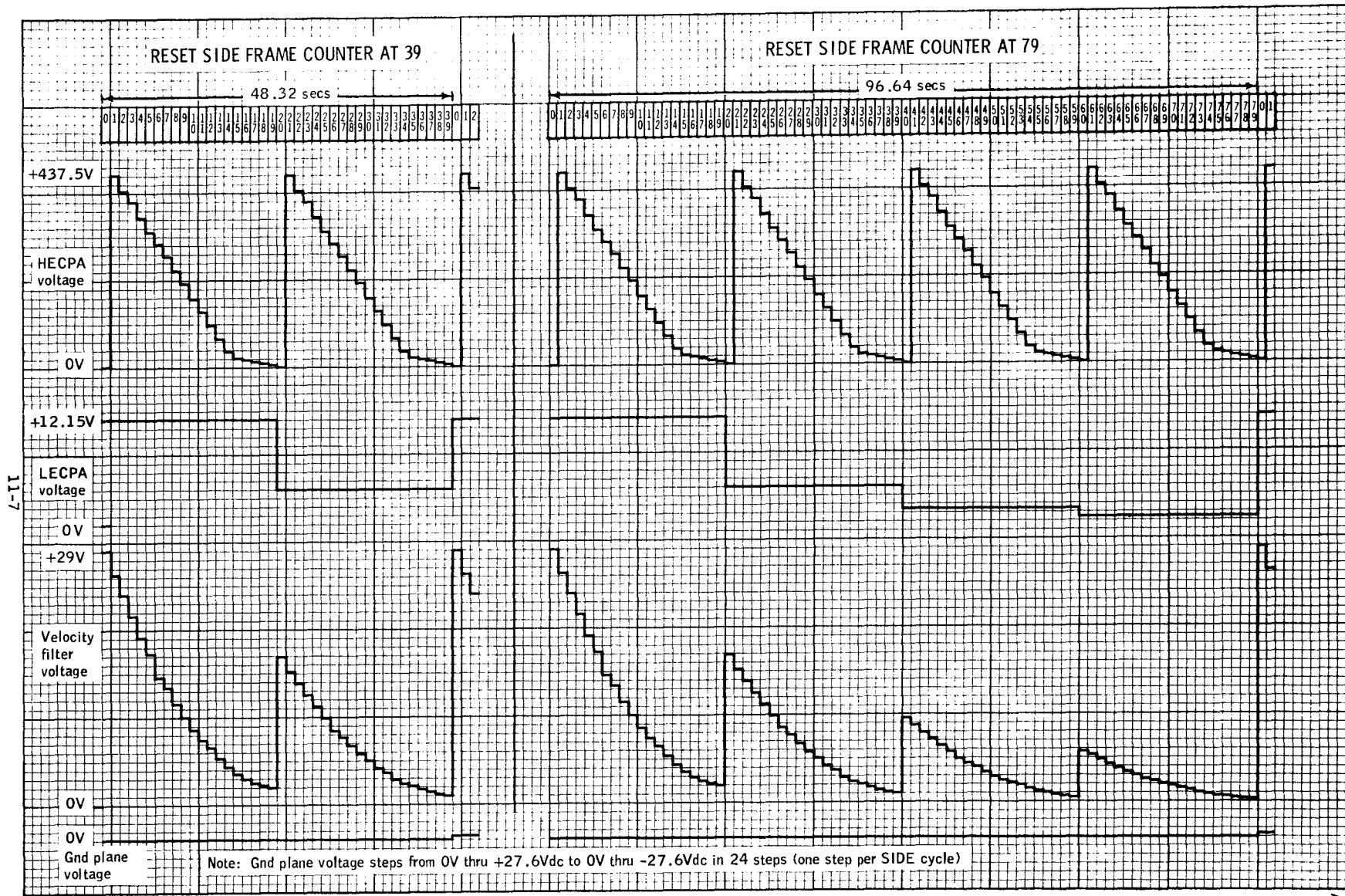
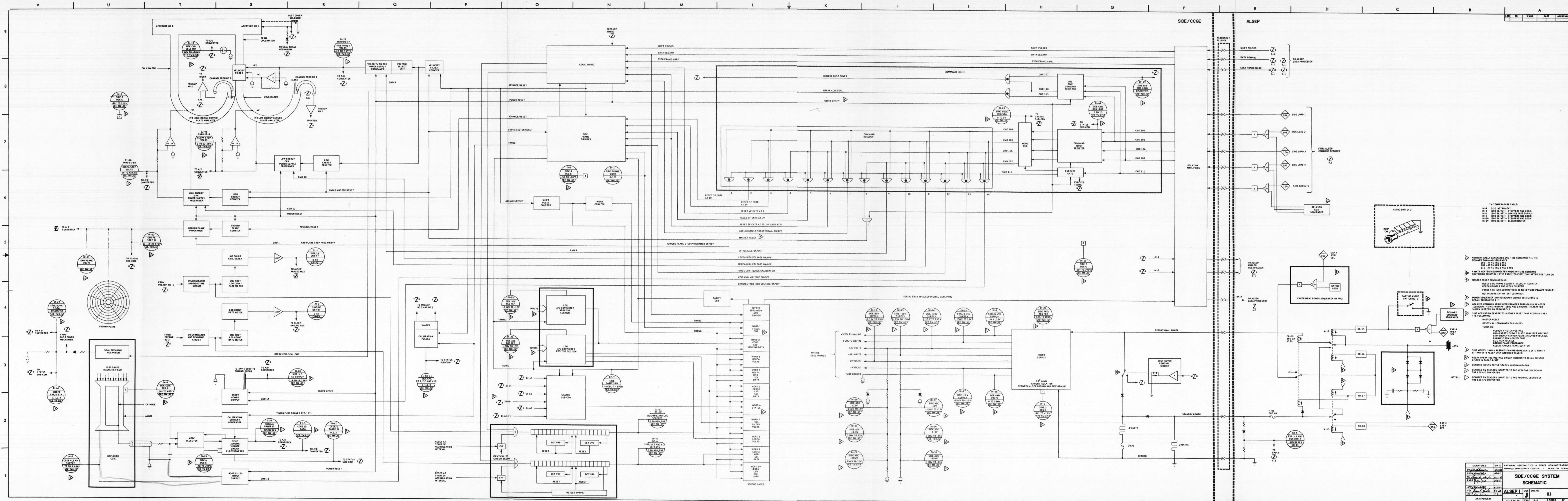

Figure 11-4. - Programed sensor voltage variations (reset at 39 and 79).



TEMPERATURE TABLE:

DI-4	CCG INSTRUMENT
DI-5	1000 BLHETI - STEPPERS AND LOGIC
DI-6	1000 BLHETI - LOW VOLTAGE SUPPLY
DI-7	1000 BLHETI - STEPPERS AND LOGIC
DI-8	1000 BLHETI - STEPPERS AND LOGIC
DI-9	1000 BLHETI - STEPPERS AND LOGIC
DI-10	1000 BLHETI - STEPPERS AND LOGIC
DI-11	1000 BLHETI - ELECTROMETER

- ▲ AUTOMATICALLY GENERATED ONE-TWO COMMANDS VIA THE DELAYED COMMAND SEQUENCER CONTAINING AN INITIAL 10⁷ Ω ISOLATED PULSE AFTER SIDE TURN ON
- ▲ A WATT HEATER DISCONNECTS WHEN ANY SIDE COMMAND CONTAINS AN INITIAL 10⁷ Ω ISOLATED PULSE
- ▲ MASTER RESET COMMANDS ALL NOT IN STATUS ON OFF COMMANDS
- ▲ RESET SIDE FRAME COUNTERS, VELOCITY FILTER COUNTER, LOGIC COUNTER AND LOGIC CONVERTER
- ▲ FORCE SIDE INTO NORMAL MODE OR TO 127 SIDE FRAMES/CYCLES
- ▲ POWER SEQUENCER AND ASTRO SWITCH NO. 3 SHOWN IN DETAIL ON DRAWING 4-2
- ▲ DELAYED COMMAND SEQUENCER PROVIDES TURN ON PULSE AFTER 100 HOURS 7.0% FROM PULSE ZERO AND 12 HOURS THEREAFTER SHOWN IN DETAIL ON DRAWING 4-3
- ▲ SIDE ACTIVATION GENERATES A POWER RESET THAT ACCUMULATES THE FOLLOWING:
 - ▲ MASTER RESET
 - ▲ RESETS ALL COMMANDS FLIP-FLOPS
 - ▲ VELOCITY FILTER VOLTAGE
 - ▲ PLATE COUNTERS CURVED PLATE ANALYZER VOLTAGE
 - ▲ CHANNEL TRON HIGH VOLTAGE
 - ▲ GROUND PLANE PROGRAMMER
 - ▲ STATUS FRAME COUNTER
- ▲ SIDE WORDS 3 AND 4 ALSO CONTAIN MEASUREMENTS OF J-PARTY BIT AND 0¹ 2¹ 3¹ 4¹ 5¹ 6¹ 7¹ 8¹ 9¹ 10¹ 11¹ 12¹ 13¹ 14¹ 15¹ 16¹ 17¹ 18¹ 19¹ 20¹ 21¹ 22¹ 23¹ 24¹ 25¹ 26¹ 27¹ 28¹ 29¹ 30¹ 31¹ 32¹ 33¹ 34¹ 35¹ 36¹ 37¹ 38¹ 39¹ 40¹ 41¹ 42¹ 43¹ 44¹ 45¹ 46¹ 47¹ 48¹ 49¹ 50¹ 51¹ 52¹ 53¹ 54¹ 55¹ 56¹ 57¹ 58¹ 59¹ 60¹ 61¹ 62¹ 63¹ 64¹ 65¹ 66¹ 67¹ 68¹ 69¹ 70¹ 71¹ 72¹ 73¹ 74¹ 75¹ 76¹ 77¹ 78¹ 79¹ 80¹ 81¹ 82¹ 83¹ 84¹ 85¹ 86¹ 87¹ 88¹ 89¹ 90¹ 91¹ 92¹ 93¹ 94¹ 95¹ 96¹ 97¹ 98¹ 99¹ 100¹ 101¹ 102¹ 103¹ 104¹ 105¹ 106¹ 107¹ 108¹ 109¹ 110¹ 111¹ 112¹ 113¹ 114¹ 115¹ 116¹ 117¹ 118¹ 119¹ 120¹ 121¹ 122¹ 123¹ 124¹ 125¹ 126¹ 127¹ 128¹ 129¹ 130¹ 131¹ 132¹ 133¹ 134¹ 135¹ 136¹ 137¹ 138¹ 139¹ 140¹ 141¹ 142¹ 143¹ 144¹ 145¹ 146¹ 147¹ 148¹ 149¹ 150¹ 151¹ 152¹ 153¹ 154¹ 155¹ 156¹ 157¹ 158¹ 159¹ 160¹ 161¹ 162¹ 163¹ 164¹ 165¹ 166¹ 167¹ 168¹ 169¹ 170¹ 171¹ 172¹ 173¹ 174¹ 175¹ 176¹ 177¹ 178¹ 179¹ 180¹ 181¹ 182¹ 183¹ 184¹ 185¹ 186¹ 187¹ 188¹ 189¹ 190¹ 191¹ 192¹ 193¹ 194¹ 195¹ 196¹ 197¹ 198¹ 199¹ 200¹ 201¹ 202¹ 203¹ 204¹ 205¹ 206¹ 207¹ 208¹ 209¹ 210¹ 211¹ 212¹ 213¹ 214¹ 215¹ 216¹ 217¹ 218¹ 219¹ 220¹ 221¹ 222¹ 223¹ 224¹ 225¹ 226¹ 227¹ 228¹ 229¹ 230¹ 231¹ 232¹ 233¹ 234¹ 235¹ 236¹ 237¹ 238¹ 239¹ 240¹ 241¹ 242¹ 243¹ 244¹ 245¹ 246¹ 247¹ 248¹ 249¹ 250¹ 251¹ 252¹ 253¹ 254¹ 255¹ 256¹ 257¹ 258¹ 259¹ 260¹ 261¹ 262¹ 263¹ 264¹ 265¹ 266¹ 267¹ 268¹ 269¹ 270¹ 271¹ 272¹ 273¹ 274¹ 275¹ 276¹ 277¹ 278¹ 279¹ 280¹ 281¹ 282¹ 283¹ 284¹ 285¹ 286¹ 287¹ 288¹ 289¹ 290¹ 291¹ 292¹ 293¹ 294¹ 295¹ 296¹ 297¹ 298¹ 299¹ 300¹ 301¹ 302¹ 303¹ 304¹ 305¹ 306¹ 307¹ 308¹ 309¹ 310¹ 311¹ 312¹ 313¹ 314¹ 315¹ 316¹ 317¹ 318¹ 319¹ 320¹ 321¹ 322¹ 323¹ 324¹ 325¹ 326¹ 327¹ 328¹ 329¹ 330¹ 331¹ 332¹ 333¹ 334¹ 335¹ 336¹ 337¹ 338¹ 339¹ 340¹ 341¹ 342¹ 343¹ 344¹ 345¹ 346¹ 347¹ 348¹ 349¹ 350¹ 351¹ 352¹ 353¹ 354¹ 355¹ 356¹ 357¹ 358¹ 359¹ 360¹ 361¹ 362¹ 363¹ 364¹ 365¹ 366¹ 367¹ 368¹ 369¹ 370¹ 371¹ 372¹ 373¹ 374¹ 375¹ 376¹ 377¹ 378¹ 379¹ 380¹ 381¹ 382¹ 383¹ 384¹ 385¹ 386¹ 387¹ 388¹ 389¹ 390¹ 391¹ 392¹ 393¹ 394¹ 395¹ 396¹ 397¹ 398¹ 399¹ 400¹ 401¹ 402¹ 403¹ 404¹ 405¹ 406¹ 407¹ 408¹ 409¹ 410¹ 411¹ 412¹ 413¹ 414¹ 415¹ 416¹ 417¹ 418¹ 419¹ 420¹ 421¹ 422¹ 423¹ 424¹ 425¹ 426¹ 427¹ 428¹ 429¹ 430¹ 431¹ 432¹ 433¹ 434¹ 435¹ 436¹ 437¹ 438¹ 439¹ 440¹ 441¹ 442¹ 443¹ 444¹ 445¹ 446¹ 447¹ 448¹ 449¹ 450¹ 451¹ 452¹ 453¹ 454¹ 455¹ 456¹ 457¹ 458¹ 459¹ 460¹ 461¹ 462¹ 463¹ 464¹ 465¹ 466¹ 467¹ 468¹ 469¹ 470¹ 471¹ 472¹ 473¹ 474¹ 475¹ 476¹ 477¹ 478¹ 479¹ 480¹ 481¹ 482¹ 483¹ 484¹ 485¹ 486¹ 487¹ 488¹ 489¹ 490¹ 491¹ 492¹ 493¹ 494¹ 495¹ 496¹ 497¹ 498¹ 499¹ 500¹ 501¹ 502¹ 503¹ 504¹ 505¹ 506¹ 507¹ 508¹ 509¹ 510¹ 511¹ 512¹ 513¹ 514¹ 515¹ 516¹ 517¹ 518¹ 519¹ 520¹ 521¹ 522¹ 523¹ 524¹ 525¹ 526¹ 527¹ 528¹ 529¹ 530¹ 531¹ 532¹ 533¹ 534¹ 535¹ 536¹ 537¹ 538¹ 539¹ 540¹ 541¹ 542¹ 543¹ 544¹ 545¹ 546¹ 547¹ 548¹ 549¹ 550¹ 551¹ 552¹ 553¹ 554¹ 555¹ 556¹ 557¹ 558¹ 559¹ 560¹ 561¹ 562¹ 563¹ 564¹ 565¹ 566¹ 567¹ 568¹ 569¹ 570¹ 571¹ 572¹ 573¹ 574¹ 575¹ 576¹ 577¹ 578¹ 579¹ 580¹ 581¹ 582¹ 583¹ 584¹ 585¹ 586¹ 587¹ 588¹ 589¹ 590¹ 591¹ 592¹ 593¹ 594¹ 595¹ 596¹ 597¹ 598¹ 599¹ 600¹ 601¹ 602¹ 603¹ 604¹ 605¹ 606¹ 607¹ 608¹ 609¹ 610¹ 611¹ 612¹ 613¹ 614¹ 615¹ 616¹ 617¹ 618¹ 619¹ 620¹ 621¹ 622¹ 623¹ 624¹ 625¹ 626¹ 627¹ 628¹ 629¹ 630¹ 631¹ 632¹ 633¹ 634¹ 635¹ 636¹ 637¹ 638¹ 639¹ 640¹ 641¹ 642¹ 643¹ 644¹ 645¹ 646¹ 647¹ 648¹ 649¹ 650¹ 651¹ 652¹ 653¹ 654¹ 655¹ 656¹ 657¹ 658¹ 659¹ 660¹ 661¹ 662¹ 663¹ 664¹ 665¹ 666¹ 667¹ 668¹ 669¹ 670¹ 671¹ 672¹ 673¹ 674¹ 675¹ 676¹ 677¹ 678¹ 679¹ 680¹ 681¹ 682¹ 683¹ 684¹ 685¹ 686¹ 687¹ 688¹ 689¹ 690¹ 691¹ 692¹ 693¹ 694¹ 695¹ 696¹ 697¹ 698¹ 699¹ 700¹ 701¹ 702¹ 703¹ 704¹ 705¹ 706¹ 707¹ 708¹ 709¹ 710¹ 711¹ 712¹ 713¹ 714¹ 715¹ 716¹ 717¹ 718¹ 719¹ 720¹ 721¹ 722¹ 723¹ 724¹ 725¹ 726¹ 727¹ 728¹ 729¹ 730¹ 731¹ 732¹ 733¹ 734¹ 735¹ 736¹ 737¹ 738¹ 739¹ 740¹ 741¹ 742¹ 743¹ 744¹ 745¹ 746¹ 747¹ 748¹ 749¹ 750¹ 751¹ 752¹ 753¹ 754¹ 755¹ 756¹ 757¹ 758¹ 759¹ 760¹ 761¹ 762¹ 763¹ 764¹ 765¹ 766¹ 767¹ 768¹ 769¹ 770¹ 771¹ 772¹ 773¹ 774¹ 775¹ 776¹ 777¹ 778¹ 779¹ 780¹ 781¹ 782¹ 783¹ 784¹ 785¹ 786¹ 787¹ 788¹ 789¹ 790¹ 791¹ 792¹ 793¹ 794¹ 795¹ 796¹ 797¹ 798¹ 799¹ 800¹ 801¹ 802¹ 803¹ 804¹ 805¹ 806¹ 807¹ 808¹ 809¹ 810¹ 811¹ 812¹ 813¹ 814¹ 815¹ 816¹ 817¹ 818¹ 819¹ 820¹ 821¹ 822¹ 823¹ 824¹ 825¹ 826¹ 827¹ 828¹ 829¹ 830¹ 831¹ 832¹ 833¹ 834¹ 835¹ 836¹ 837¹ 838¹ 839¹ 840¹ 841¹ 842¹ 843¹ 844¹ 845¹ 846¹ 847¹ 848¹ 849¹ 850¹ 851¹ 852¹ 853¹ 854¹ 855¹ 856¹ 857¹ 858¹ 859¹ 860¹ 861¹ 862¹ 863¹ 864¹ 865¹ 866¹ 867¹ 868¹ 869¹ 870¹ 871¹ 872¹ 873¹ 874¹ 875¹ 876¹ 877¹ 878¹ 879¹ 880¹ 881¹ 882¹ 883¹ 884¹ 885¹ 886¹ 887¹ 888¹ 889¹ 890¹ 891¹ 892¹ 893¹ 894¹ 895¹ 896¹ 897¹ 898¹ 899¹ 900¹ 901¹ 902¹ 903¹ 904¹ 905¹ 906¹ 907¹ 908¹ 909¹ 910¹ 911¹ 912¹ 913¹ 914¹ 915¹ 916¹ 917¹ 918¹ 919¹ 920¹ 921¹ 922¹ 923¹ 924¹ 925¹ 926¹ 927¹ 928¹ 929¹ 930¹ 931¹ 932¹ 933¹ 934¹ 935¹ 936¹ 937¹ 938¹ 939¹ 940¹ 941¹ 942¹ 943¹ 944¹ 945¹ 946¹ 947¹ 948¹ 949¹ 950¹ 951¹ 952¹ 953¹ 954¹ 955¹ 956¹ 957¹ 958¹ 959¹ 960¹ 961¹ 962¹ 963¹ 964¹ 965¹ 966¹ 967¹ 968¹ 969¹ 970¹ 971¹ 972¹ 973¹ 974¹ 975¹ 976¹ 977¹ 978¹ 979¹ 980¹ 981¹ 982¹ 983¹ 984¹ 985¹ 986¹ 987¹ 988¹ 989¹ 990¹ 991¹ 992¹ 993¹ 994¹ 995¹ 996¹ 997¹ 998¹ 999¹ 1000¹ 1001¹ 1002¹ 1003¹ 1004¹ 1005¹ 1006¹ 1007¹ 1008¹ 1009¹ 1010¹ 1011¹ 1012¹ 1013¹ 1014¹ 1015¹ 1016¹ 1017¹ 1018¹ 1019¹ 1020¹ 1021¹ 1022¹ 1023¹ 1024¹ 1025¹ 1026¹ 1027¹ 1028¹ 1029¹

